



Katalog Catalogue



Obsah	01
1. KNOFLÍKY STISKACÍ	1.01
Přišívací	
Mosazné	KIN 1.01
Plastové	MIA 1.03
Nýtovací, bez přišívání	
Na silné látky	AUTO MOTO 1.05
Na velmi silné látky, s vysokými nýty..	AUTO MOTO 1.06
Na silné látky, s vrutem	AUTO MOTO 1.08
Na středně silné látky	WUK 1.10
Na středně silné látky, vodotěsné	WUK 1.14
Speciální aplikace pro průmysl	LORD 1.16
Peněženkový uzávěr	LORD 1.16
Na plachtovinu a kůži	KIN DOT 1.17
Na slabé látky	ROLAND 1.19
2. KNOFLÍKY ZAPÍNACÍ	2.01
Přišívací	
Willy	EXCELSIOR 2.01
Pro ruční potahování	IDEAL 2.01
Bez přišívání	
Nesnímatelné	CORSO 2.01
Nesnímatelné, jeansové	FOREVER 2.03
Snímatelné, plastový svršek	DRESSKING 2.05
Snímatelné, kovový svršek s rytinou ..	SPORT 2.05
Kalhotové nýty	
Ozdobné	LIBERTY 2.07
3. KOVOVÁ GALANTERIE	3.01
Průchodky	
.....	LORD 3.01
Háčky a očka	
.....	BUTTERFLY 3.03
Kalhotová a sukňová spínadla, háky a přezky	
Kalhotová spínadla	DOT 3.03
Kalhotová spínadla	KIN 3.05
Sukňová spínadla	KIN 3.05
Kalhotové háky 3.06
Šlové součásti	
Šlové součásti, závěsy 3.07
Šlové součásti, přezky 3.10
Šlové součásti, trojúhelníky 3.11
Příslušenství pro spodní prádlo, bikiny, kravaty a ponožky	
Podvazkové držáky	CAVALIER 3.12
Plavkové zapínání	CAVALIER 3.12
Kravatové kování	CAVALIER 3.14
Pánské podvazky	CAVALIER 3.14
Náprstky	BON AMI 3.15
Spony vlasové	VIOLA 3.17
Koncovka plastová s víčkem 3.19
4. SPOJOVACÍ MATERIÁLY	4.01
Nýty	
Otevřené 4.01
Uzavřené 4.01
S povlakem 4.02
Kované 4.02
Spojovací materiály	
Plachtové díly 4.03
Kroužek pořadače hřebetní 4.03
Kroužek pořadače oválný 4.03
Quick spojovací prvky 4.04
IXA hřebíčky 4.04
5. ŠPENDLÍKY	5.01
Špendlíky napichovací	
Ocel měkká	RIVAL 5.01
Ocel měkká - tenké	RIVAL 5.01
Ocel měkká - tenké, velká hlava	RIVAL 5.02
Ocel kalená	RIVAL 5.02
Mosazné	RIVAL 5.03
Špendlíky napichovací, speciální	
Se skleněnou hlavou	RIVAL 5.03
S plastovou hlavou, kalené	RIVAL 5.03
S plastovou hlavou, ocelové	RIVAL 5.03
Špendlíky spínací	
Ocelové	DUPLEX 5.05
Ocelové, barevné	DUPLEX Color 5.07
Dětské bezpečností nerezové	SIMPLEX 5.07
Ocelové, kalené	DUPLEX Special.. 5.09
Mosazné, nerezavějící	DUPLEX Goldin .. 5.09
Nerezové	DUPLEX 5.09
Nerezovo-mosazné, zahnuté	DUPLEX Special.. 5.10
8. DROBNÉ PRŮMYSLOVÉ VÝROBKY	8.01
Drobné průmyslové výrobky	
Holubí jehlice 8.01
Věncové spony 8.01
Držák knotu 8.01
Koncovka lanka 8.01
Osičky 8.02
Sedlové spony 8.02
Kryt rohu 8.03
Krycí růžek 8.03
POVRCHOVÉ ÚPRAVY, RYTINY A LASERY	C.01
Povrchové úpravy	
Povrchové úpravy C.01
Rytiny - lasery	
Rytiny - lasery C.03
Barevnice	
Barevné laky C.04
Metallické laky C.04
Čocky dekorativní (Roland Decor) C.05
Knoflíky, plastové knoflíky (Dressking) C.05
NÝTOVACÍ PŘÍSLUŠENSTVÍ	P.01
Nýtovací příslušenství	
Lisy P.01
Pistony, nýtovadla P.02
Kleště P.03
Náhradní nýtovadla univerzální P.05
Nýtovací podložky pro Auto Moto a WUK P.05
W. KREJČOVSKÉ POTŘEBY	W.01
Krejčovské potřeby	
Nůžky štipky W.01
Centimetry W.01
Páradla W.01
Navlékač jehel W.03
Šitíčka W.05
DOSTUPNÉ VÝROBNÍ TECHNOLOGIE	

Content

z a p í n á m e c e l ý s v ě t



Content 02

1. SNAP FASTENERS 1.01

Sew-on	Brass	KIN	1.01
	Plastic	MIA	1.03
Non-sew	For thick material	AUTO MOTO	1.05
	For very thick material, high rivets	AUTO MOTO	1.06
	For thick material, with screw	AUTO MOTO	1.08
	For middle thick material	WUK	1.10
	For middle thick material, watertight..	WUK	1.14
	Special applications	LORD	1.16
	Purse-closure	LORD	1.16
	For canvas and leather	KIN DOT	1.17
	For thin material	ROLAND	1.19

2. BUTTONS 2.01

Sew-on	Willy	EXCELSIOR	2.01
	Self covered	IDEAL	2.01
Non-sew	Unremovable	CORSO	2.01
	Unremovable, jeans	FOREVER	2.03
	Detachable, plastic upper	DRESSKING	2.05
	Detachable, brass upper	SPORT	2.05
Decorative rivets	Flat, convex	LIBERTY	2.07

3. METAL HABERDASHERY 3.01

Eyelets	LORD	3.01
Hooks & eyes	BUTTERFLY	3.03
Trouser & skirt hooks, buckles	Trouser hooks	DOT	3.03
	Trouser hooks	KIN	3.05
	Skirt hooks	KIN	3.05
	Trouser hooks	3.06
Brace accessories	Brace clips	3.07
	Brace buckles	3.10
	Brace fittings	3.11
Lingerie, bikini, tie & socks accessories	Suspenders with ribbon	CAVALIER	3.12
	Bikini clasps	CAVALIER	3.12
	Tie fittings	CAVALIER	3.14
	Men suspenders	CAVALIER	3.14
Thimbles	BON AMI	3.15
Hair pins	VIOLA	3.17
Plastic cord end with a cap	3.19

4. CONNECTING MATERIALS 4.01

Rivets	Drawned rivets, open	4.01
	Drawned rivets, closed	4.01
	Drawned rivets, with coating	4.02
	Forged rivets	4.02
	Canvas parts	4.03
Other connecting materials	Eyelets for binding	4.03
	Oval eyelets for binding	4.03
	Quick, connecting part for pipeline	4.04
	IXA nails	4.04

5. STRAIGHT & SAFETY PINS 5.01

Straight pins	Mild steel	RIVAL	5.01
	Mild steel - thin	RIVAL	5.01
	Mild steel - thin, big head	RIVAL	5.02
	Hard steel	RIVAL	5.02
	Brass, rustproof	RIVAL	5.03
Straight pins, special	With glass head, hard steel	RIVAL	5.03
	With plastic head, hard steel	RIVAL	5.03
	With plastic head, mild steel	RIVAL	5.03
Safety pins	Steel	DUPLEX	5.05
	Steel, colourful	DUPLEX Colour..	5.07
	Children safety pins, stainless steel ...	SIMPLEX	5.07
	Hard steel	DUPLEX Special..	5.09
	Brass, rustproof	DUPLEX Goldin..	5.09
	Stainless steel & brass, rustproof	DUPLEX	5.09
	Special, curved - for patchwork	DUPLEX Special..	5.10

8. SMALL INDUSTRIAL PRODUCTS 8.01

Small industrial products	Stainless steel pigeon needles	8.01
	Wreath clasps	8.01
	Wick holder	8.01
	Cable end	8.01
	Axes	8.02
	Saddle buckles, hard steel	8.02
	Corner covers	8.03
	Covering corners	8.03

FINISH SURFACES, ENGRAVINGS, COLOUR CARDS C.01

Finish surfaces	Finish surfaces	C.01
Engravings, lasers	Engravings, lasers	C.03
Colour cards	Colour lacquer	C.04
	Metallic lacquer	C.04
	Decorative lens for press fasteners Roland Decor	C.05
	Detachable buttons, Dressking Colour	C.05

RIVETING ACCESSORIES P.01

Riveting accessories	Presses	P.01
	Tools	P.02
	Pliers	P.03
	Replacement tools for retail cards - UNI clamp	P.05
	Riveting washer for AUTO MOTO, WUK	P.05

W. TAILORING NEEDS W.01

Tailoring needs	Thread cutters	W.01
	Rulers	W.01
	Seam rippers	W.01
	Needle threaders	W.03
	Sewing kits	W.05

AVAILABLE MANUFACTURING TECHNOLOGIES

KNOFLÍKY STISKACÍ • SNAP FASTENERS •

1

z a p í n á m e c e l ý s v ě t



10 PŘÍŠÍVACÍ MOSAZNÉ • FOR SEWING – BRASS

Art.	Velikost / Size	D / D1 (mm)	Materiál / Material	mosaz / brass
10021		8	21/21	<p>STANDARDNÍ POVRCHOVÁ ÚPRAVA nikl free, nikl, černý lak, mosaz, staromosaz, barevný lak bílý</p> <p>STANDARDNÍ BALENÍ MO karty: dle velikosti 3, 4, 6, 8, 15 ks MO karty velké: dle velikosti 16, 24, 36 ks sypané: 12 celků (1 celek = 144 ks)</p> <p>Použití K zapínání různých částí oděvů.</p> <p>STANDARD SURFACE FINISH nickel free, nickel, black lacquer, brass, old brass, colour lacquer white</p> <p>STANDARD PACKING retail cards: according to size 3, 4, 6, 8, 15 pcs retail cards big: according to size 16, 24, 36 pcs loose: 12 gross (1 gross = 144 pcs)</p> <p>APPLICATION Closing of various clothing parts.</p>
10019		7	19/18	
10016		6	16/15	
10014		5	14/13	
10012		4	12/11	
10011		3	11/10	
10010		2	10/9	
10009		1	9/8	
10008		1/2	8/7	
10007		0	7/6	
10006		2/0	6/5	



UKÁZKA BALENÍ • ILLUSTRATION OF PACKING • 1

10 KNOFLÍKY STISKACÍ PŘÍŠÍVACÍ MOSAZNÉ • SNAP FASTENERS FOR SEWING - BRASS



KNOFLÍKY STISKACÍ • SNAP FASTENERS •

1

z a p í n á m e c e l ý s v ě t



11 PŘÍŠÍVACÍ PLASTOVÉ • FOR SEWING – PLASTIC

Art.	Velikost / Size	D (mm)	Materiál / Material ▶ plast / plastic
11015		6 15	<p>▶ STANDARDNÍ POVRCHOVÁ ÚPRAVA barva plastu transparentní, bílá, černá, béžová, staromosaz, nikl antik, individuální barva dle barevnice Knoflíky plastové C.10 a C.11</p> <hr/> <p>STANDARDNÍ BALENÍ MO karty: dle velikosti 9, 12, 20, 24 ks sypané: dle velikosti 450, 600, 1000, 1200, 1500, 2500, 3000 ks</p> <hr/> <p>Použití K zapínání různých částí oděvů.</p> <hr/> <p>▶ STANDARD SURFACE FINISH transparent, white, black, beige, old brass, nickel antique, individual colour according to color chart Plastic buttons C.10 and C.11</p> <hr/> <p>STANDARD PACKING retail cards: according to size 9, 12, 20, 24 pcs loose: according to size 450, 600, 1000, 1200, 1500, 2500, 3000 pcs</p> <hr/> <p>APPLICATION Closing of various clothing parts.</p>
11013		5 13	
11010		3 10	
11007		1/2 7	

transparentní
transparent



bílá
white



černá
black



béžová
beige



růžová
pink



modrá
blue



staromosaz
old brass



nikl antik
nickel antique





UKÁZKA BALENÍ • ILLUSTRATION OF PACKING • 1

11 KNOFLÍKY STISKACÍ PŘÍŠIVACÍ PLASTOVÉ • SNAP FASTENERS FOR SEWING - PLASTIC



KNOFLÍKY STISKACÍ • SNAP FASTENERS •

1

z a p í n á m e c e l ý s v ě t



Auto
MOTO

12 NÝTOVACÍ NA SILNÉ LÁTKY • FOR THICK MATERIAL

Art.	Velikost / Size	D (mm)	Materiál / Material	Povlak / Coat
12103	3	9,5	mosaz / brass	mosaz / brass

	<p>TLOUŠŤKA MATERIÁLU 0,5 - 1,5 mm</p> <p>ROZPINACÍ SÍLA 15 - 30 N</p>	<p>THICKNESS OF MATERIAL 0,5 - 1,5 mm</p> <p>UNBUTTON FORCE 15 - 30 N</p>	<p>STANDARDNÍ POVRCHOVÁ ÚPRAVA nikl, černý nikl, staromosaz</p> <p>STANDARDNÍ BALENÍ sypané: 500 ks</p>	<p>STANDARD SURFACE FINISH nickel, black nickel, old brass</p> <p>STANDARD PACKING loose: 500 pcs</p>
--	--	---	---	---

Ostatní díly / OTHER PARTS	pérová část / spring	kulička / ball	nýt kuličky / rivet
----------------------------	----------------------	----------------	---------------------

--	--	--

12 NÝTOVACÍ NA SILNÉ LÁTKY • FOR THICK MATERIAL

Art.	Velikost / Size	D (mm)	Materiál / Material	Povlak / Coat
12105	5	13,5	mosaz / brass	mosaz / brass
12106	6	15	mosaz / brass	mosaz / brass
12107	7	17	mosaz / brass	mosaz / brass

<p>STANDARDNÍ POVRCHOVÁ ÚPRAVA nikl, černý nikl, nikl antik, mosaz, staromosaz, měď, staroměď, barevný lak dle barevnice Barevný lak, metalický lak dle barevnice Metalický lak</p> <p>STANDARDNÍ BALENÍ MO karty: velikost 5, 6 10ks sypané: 100, 500, 2000 ks</p>	<p>STANDARD SURFACE FINISH nickel, black nickel, nickel antique, brass, old brass, copper, old copper, colour lacquer according to colour card Colour lacquer, metallic lacquer according to colour card Metallic lacquer</p> <p>STANDARD PACKING retail cards: size 5, 6 10 pcs loose: 100, 500, 2000 pcs</p>
---	--

Ostatní díly / OTHER PARTS	pérová část / spring	kulička / ball	nýt kuličky / rivet
----------------------------	----------------------	----------------	---------------------

--	--	--

Art.	Velikost / Size	D (mm)	Materiál / Material	Povlak / Coat
12206	6	15	plast / plastic	plast / plastic

<p>STANDARDNÍ POVRCHOVÁ ÚPRAVA nikl, černý nikl, nikl antik, mosaz, staromosaz barva plastového povlaku dle barevnice knoflíky plastové</p> <p>STANDARDNÍ BALENÍ MO karty: 10 ks sypané: 100, 500 ks</p>	<p>STANDARD SURFACE FINISH nickel, black nickel, nickel antique, brass, old brass Colours of plastic upper part according to colour card plastic buttons</p> <p>STANDARD PACKING retail cards: 10 pcs loose: 100, 500 pcs</p>
--	---

Ostatní díly / OTHER PARTS	pérová část / spring	kulička / ball	nýt kuličky / rivet
----------------------------	----------------------	----------------	---------------------

--	--	--

KNOFLÍKY STISKACÍ • SNAP FASTENERS •

1

Auto
MOTO

12 NÝTOVACÍ NA SILNÉ LÁTKY • FOR THICK MATERIAL

Art.	Velikost / Size	D (mm)	Materiál / Material	Povlak / Coat
12706	6	15	ocel / steel	ocel / steel

STANDARDNÍ POVRCHOVÁ ÚPRAVA nikl	STANDARD SURFACE FINISH nickel		
STANDARDNÍ BALENÍ sypané: 500 ks	STANDARD PACKING loose: 500 pcs		
OSTATNÍ DÍLY OTHER PARTS	pérová část spring	kulička ball	nýt kuličky rivet



12 NÝTOVACÍ NA VELMI SILNÉ LÁTKY • FOR VERY THICK MATERIAL

Art.	Velikost / Size	D (mm)	Materiál / Material
1216W	6	15	mosaz / brass

OBA NÝTY VYSOKÉ • BOTH RIVETS HIGH

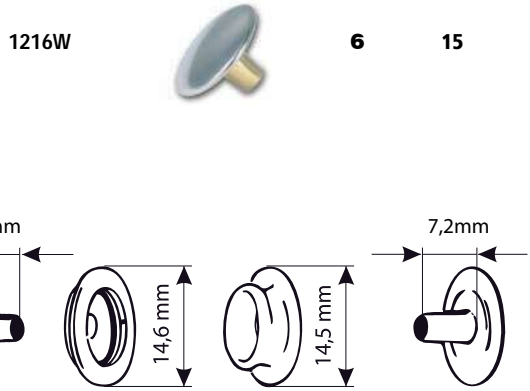

STANDARDNÍ POVRCHOVÁ ÚPRAVA nikl, černý nikl, nikl antik, staromosaz	STANDARD SURFACE FINISH nickel, black nickel, nickel antique, old brass		
STANDARDNÍ BALENÍ MO karty: velikost 6 10 ks sypané: 100, 500 ks	STANDARD PACKING retail cards: size 6 10 pcs loose: 100, 500 pcs		
Použití Pro materiály o tloušťce 3 – 5 mm, kůže aj.	APPLICATION For materials with a thickness of 3 - 5 mm, leather, etc.		
OSTATNÍ DÍLY OTHER PARTS	pérová část spring	kulička ball	nýt kuličky rivet



TLOUŠŤKA MATERIÁLU 3 – 5 mm	THICKNESS OF MATERIAL 3 – 5 mm
ROZPINACÍ SÍLA 15 – 40 N	UNBUTTON FORCE 15 – 40 N

Art.	D (mm)	Materiál / Material
13A13	13	plast / plastic
12A15	15	plast / plastic



podložka • washer

STANDARDNÍ BALENÍ MO karty: 20 ks sypané: 500 ks	STANDARD PACKING retail cards: 20 pcs loose: 500 pcs
Použití Pro snížení výšky nýtu kuličky, zabráňuje poškození materiálu při rozepínání oděvu.	APPLICATION For reduction of ballrivet. It prevents material from damaging at fastening.

z a p í n á m e c e l ý s v ě t



STANDARD

SPECIAL

► vysoký nýt svršku vel. 6; kulička s pevným stiskem;
vysoký nýt kuličky

► high rivet cap size 6; ball with fast press;
high ball rivet

JEDNOTLIVÉ DÍLY LZE VZÁJEMNĚ KOMBINOVAT
SINGLE PARTS CAN BE COMBINED

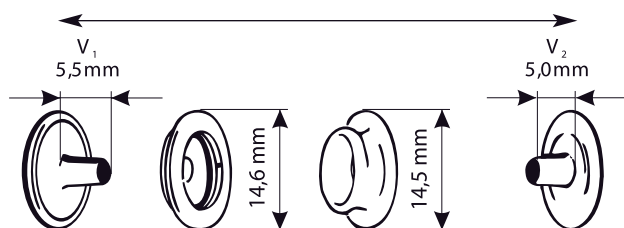

► TLOUŠŤKA MATERIÁLU
1 – 3 mm

ROZPINACÍ SÍLA
15 – 40 N

► THICKNESS OF MATERIAL
1 – 3 mm

UNBUTTON FORCE
15 – 40 N

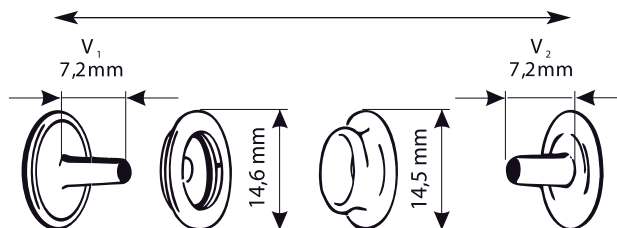

► TLOUŠŤKA MATERIÁLU
3 – 5 mm

ROZPINACÍ SÍLA
30 – 70 N

► THICKNESS OF MATERIAL
3 – 5 mm

UNBUTTON FORCE
30 – 70 N

BAREVNICE • COLOUR CARD PLAST POVLAKY / PLASTIC COATINGS



Použití

Ke spojování silných a pevných druhů látek – kůže, plachtovina aj. méně poddajné materiály.

Pro nýtování nabízíme ruční nebo pneumatické lisy s výměnitelnými pistony.

Materiál doporučujeme předem vyděrovat, u pneumatického lisu není děrování ve většině případů potřeba.

Poznámka

Na základě požadavků zákazníka jsou možné i ostatní povrchové úpravy dle katalogového listu POVRCHOVÉ ÚPRAVY.

Ražby na svršku knoflíku jsou vyráběny dle katalogového listu RYTINY KIN nebo dle přání zákazníka.

Application

Fastening of strong and heavy material – leather, canvas and similar material.

For riveting we offer you presses with various tools.

We recommend to punch the material in advance, not necessary by using pneumatic press.

Note

We can produce also another surface finishing according catalogue list FINISH SURFACE.

Cap can be produced also with mint according catalogue list ENGRAVINGS KIN or customer's request.

KNOFLÍKY STISKACÍ • SNAP FASTENERS •

1

z a p í n á m e c e l ý s v ě t



Auto
MOTO 

12 NÝTOVACÍ NA SILNÉ LÁTKY • FOR THICK MATERIAL

Art.	Velikost / Size	D (mm)	• Materiál / Material ▶ mosaz / brass
			• Povlak / Coat ▶ mosaz / brass
			• Vrut / Screw ▶ nerez / stainless steel

S VRUTEM • WITH SCREW

12406



6

15

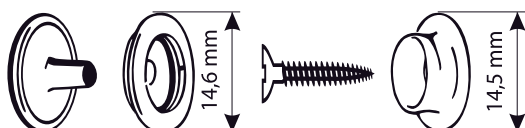

STANDARDNÍ POVRCHOVÁ ÚPRAVA nikl, černý nikl	STANDARD SURFACE FINISH nickel, black nickel
STANDARDNÍ BALENÍ MO karty: 10 ks sypané: 500 ks	STANDARD PACKING retail cards: 10 pcs loose: 500 pcs
Použití Ke spojování běžných druhů látek s pevnými materiály (např. dřevo).	APPLICATION For the fastening of common with firm material (wood etc.).

OSTATNÍ DÍLY

OTHER PARTS

pérová část
spring

kulička
ball

vrut
screw



Ø – 3,5 mm
V – 16 mm

Art.	Velikost / Size	D (mm)	• Materiál / Material ▶ mosaz / brass
------	-----------------	--------	---------------------------------------

AMI

kulička
ball

pérová část
spring

nýt
rivet

12116

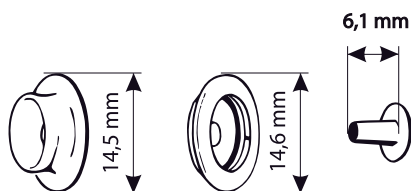

STANDARDNÍ POVRCHOVÁ ÚPRAVA nikl, černý nikl	STANDARD SURFACE FINISH nickel, black nickel
STANDARDNÍ BALENÍ sypané: 500 ks	STANDARD PACKING loose: 500 pcs
Použití Mezikus pro Auto Moto, ke spojování tří a více vrstev látek v jednom místě.	APPLICATION Intermediate part for Auto Moto, for joining of three and more layers of fabrics at one place.

UKÁZKA POUŽITÍ • ILLUSTRATION OF USE



Auto Moto
vrchní díly • upper parts



AMI



Auto Moto
spodní díly • bottom parts



UKÁZKA BALENÍ • 1 ILLUSTRATION OF PACKING • 1

12 KNOFLÍKY STISKACÍ NÝTOVACÍ NA SILNÉ A VELMI SILNÉ LÁTKY
SNAP FASTENERS FOR THICK AND VERY THICK MATERIAL



Auto
MOTO

KNOFLÍKY STISKACÍ • SNAP FASTENERS •

1

z a p í n á m e c e l ý s v ě t



13 NÝTOVACÍ NA STŘEDNĚ SILNÉ LÁTKY • FOR MIDDLE THICK MATERIAL

Art.	Velikost / Size	D (mm)
13132	3/2	10,5

TLOUŠTKA MATERIÁLU 0,5 – 1,5 mm	THICKNESS OF MATERIAL 0,5 – 1,5 mm
ROZPÍNAČÍ SÍLA 15 – 30 N	UNBUTTON FORCE 15 – 30 N

• Materiál / Material	▶ mosaz / brass
• Povlak / Coat	▶ mosaz / brass
▶	▶
STANDARDNÍ POVRCHOVÁ ÚPRAVA nikl, černý nikl, nikl antik, mosaz, staromosaz, barevný lak dle barevnice Barevný lak	STANDARD SURFACE FINISH nickel, black nickel, nickel antique, brass, old brass, colour lacquer according to colour card Colour lacquer
STANDARDNÍ BALENÍ sypané: 500 ks	STANDARD PACKING loose: 500 pcs

OSTATNÍ DÍLY OTHER PARTS	pérová část spring	kulička ball	nýt kuličky rivet
------------------------------------	-----------------------	-----------------	----------------------

Art.	Velikost / Size	D (mm)
13144	4/4	11,5
13154	5/4	13,5
13164	6/4	15

• Materiál / Material	▶ mosaz / brass
• Povlak / Coat	▶ mosaz / brass
▶	▶
STANDARDNÍ POVRCHOVÁ ÚPRAVA nikl, černý nikl, nikl antik, mosaz, staromosaz, staroměď, barevný lak dle barevnice Barevný lak	STANDARD SURFACE FINISH nickel, black nickel, nickel antique, brass, old brass, old copper, colour lacquer according to colour card Colour lacquer
STANDARDNÍ BALENÍ MO karty: velikost 5/4, 6/4 10 ks sypané: 100, 500 ks	STANDARD PACKING retail cards: size 5/4, 6/4 10 pcs loose: 100, 500 pcs

OSTATNÍ DÍLY OTHER PARTS	pérová část spring	kulička ball	nýt kuličky rivet
------------------------------------	-----------------------	-----------------	----------------------

Art.	Velikost / Size	D (mm)
13264	6/4	15

TLOUŠTKA MATERIÁLU 0,5 – 1,5 mm	THICKNESS OF MATERIAL 0,5 – 1,5 mm
ROZPÍNAČÍ SÍLA 15 – 30 N	UNBUTTON FORCE 15 – 30 N

• Materiál / Material	▶ mosaz / brass
• Povlak / Coat	▶ plast / plastic
▶	▶
STANDARDNÍ POVRCHOVÁ ÚPRAVA nikl, černý nikl, barva plastu dle barevnice knoflíky plastové	STANDARD SURFACE FINISH nickel, black nickel, colours according to colour card plastic buttons
STANDARDNÍ BALENÍ MO karty: velikost 6/4 10 ks	STANDARD PACKING retail cards: size 6/4 10 pcs

OSTATNÍ DÍLY OTHER PARTS	pérová část spring	kulička ball	nýt kuličky rivet
------------------------------------	-----------------------	-----------------	----------------------

KNOFLÍKY STISKACÍ • SNAP FASTENERS •

1

z a p í n á m e c e l ý s v ě t



13 NÝTOVACÍ NA STŘEDNĚ SILNÉ LÁTKY • FOR MIDDLE THICK MATERIAL

Art. Velikost / Size D (mm)

• Materiál / Material ▶ mosaz / brass

• Povlak / Coat ▶ mosaz / brass

13156 5/6 13,5



STANDARDNÍ POVRCHOVÁ ÚPRAVA
nikl, černý nikl, nikl antik, mosaz, staromosaz,
barevný lak dle barevnice Barevný lak

STANDARD SURFACE FINISH
nickel, black nickel, nickel antique, brass,
old brass, colour lacquer according to colour
card Colour lacquer

13166 6/6 15



STANDARDNÍ BALENÍ
sypané: 100, 500 ks

STANDARD PACKING
loose: 100, 500 pcs

OSTATNÍ DÍLY
OTHER PARTS

pérová část
spring

kulička
ball

nýt kuličky
rivet

13176 7/6 17



Art. Velikost / Size D (mm)

• Materiál / Material ▶ mosaz / brass

• Povlak / Coat ▶ plast / plastic

13266 6/6 15



STANDARDNÍ POVRCHOVÁ ÚPRAVA
nikl, černý nikl, barva plastu dle barevnice
knoflíky plastové

STANDARD SURFACE FINISH
nickel, black nickel, colours according to colour
card plastic buttons

STANDARDNÍ BALENÍ
sypané: 100, 500 ks

STANDARD PACKING
loose: 100, 500 pcs

OSTATNÍ DÍLY
OTHER PARTS

pérová část
spring

kulička
ball

nýt kuličky
rivet



Art. D (mm)

• Materiál / Material ▶ plast / plastic

13A13 13



STANDARDNÍ BALENÍ
MO karty: 20 ks
sypané: 500 ks

STANDARD PACKING
retail cards: 20 pcs
loose: 500 pcs

12A15 15



Použití
Pro snížení výšky nýtu kuličky, zabráňuje
poškození materiálu při rozepínání oděvu.

APPLICATION
For reduction of ballrivet. It prevents
material from damaging at fastening.

podložka • washer

KNOFLÍKY STISKACÍ • SNAP FASTENERS •

1

z a p í n á m e c e l ý s v ě t



13 NÝTOVACÍ NA STŘEDNĚ SILNÉ LÁTKY • FOR MIDDLE THICK MATERIAL

STANDARD

VELIKOST
5/6; 6/6; 7/6

SIZE
5/6; 6/6; 7/6

SPECIAL

VELIKOST
5/6; 6/6; 7/6

kulička s pevným stiskem; vysoký nýt kuličky; u velikosti 6/6 vysoký nýt svršku

SIZE
5/6; 6/6; 7/6

ball with fast press; high ball rivet; size 6/6 - high rivet cap

JEDNOTLIVÉ DÍLY LZE VZÁJEMNĚ KOMBINOVAT • SINGLE PARTS CAN BE COMBINED

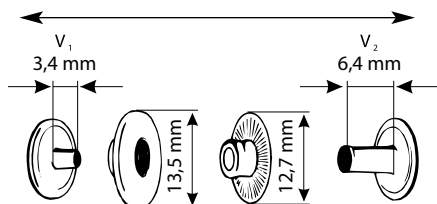

TLOUŠTKA MATERIÁLU
0,5 – 2,0 mm

ROZPÍNACÍ SÍLA
15 – 30 N

THICKNESS OF MATERIAL
0,5 – 2,0 mm

UNBUTTON FORCE
15 – 30 N

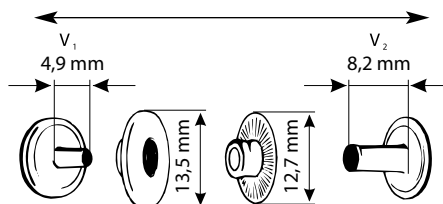

TLOUŠTKA MATERIÁLU
2 – 4 mm

ROZPÍNACÍ SÍLA
30 – 60 N

THICKNESS OF MATERIAL
2 – 4 mm

UNBUTTON FORCE
30 – 60 N

BAREVNICE • COLOUR CARD PLAST POVLAKY / PLASTIC COATINGS



Použití

Ke spojování středně silných druhů látek – textilie, usně, koženky aj.

Pro nýtování nabízíme ruční nebo pneumatické lisy s vyměnitelnými pistony.

Materiál doporučujeme předem vyděrovat, u pneumatického lisu není děrování ve většině případů potřeba.

Poznámka

Na základě požadavků zákazníka jsou možné i ostatní povrchové úpravy dle katalogového listu POVRCHOVÉ ÚPRAVY.

Ražby na svršku knoflíku jsou vyráběny dle katalogového listu RYTINY KIN nebo dle přání zákazníka.

Application

For joint of thinner materials – textile, leather, leatherette etc.

For riveting we offer you presses with various tools.

We recommend to punch the material in advance, not necessary by using pneumatic press.

Note

We can produce also another surface finishing according catalogue list FINISH SURFACE.

Cap can be produced also with mint according catalogue list ENGRAVINGS KIN or customer's request.



UKÁZKA BALENÍ • ILLUSTRATION OF PACKING • 1

13 KNOFLÍKY STISKACÍ NÝTOVACÍ NA STŘEDNĚ SILNÉ LÁTKY • SNAP FASTENERS FOR MIDDLE THICK MATERIAL



KNOFLÍKY STISKACÍ • SNAP FASTENERS •

1

z a p í n á m e c e l ý s v ě t



13 NÝTOVACÍ VODOTĚSNÝ • WATERTIGHT

Art. Velikost / Size D (mm)

- Materiál / Material ▶ mosaz / brass
- Povlak / Coat ▶ mosaz / brass

1315T  **5/6** **13,5**

STANDARDNÍ PОВRCHOVÁ ÚPRAVA
nikl, černý nikl, staromosaz

STANDARD SURFACE FINISH
nickel, black nickel, old brass

STANDARDNÍ BALENÍ
MO karty: 10 ks
sypané: 500 ks

STANDARD PACKING
retail cards: 10 pcs
loose: 500 pcs

1316T  **6/6** **15**

OSTATNÍ DÍLY OTHER PARTS pérová část spring kulička ball nýt kuličky rivet



nepropustná PH vložka
watertight plastic pad

Art. Velikost / Size D (mm)

- Materiál / Material ▶ mosaz / brass
- Povlak / Coat ▶ plast / plastic

1326T  **6/6** **15**

STANDARDNÍ PОВRCHOVÁ ÚPRAVA
nikl, černý nikl, barva plastu dle barevnice
knoflíky plastové

STANDARD SURFACE FINISH
nickel, black nickel, colours according to colour
card plastic buttons

STANDARDNÍ BALENÍ
MO karty: velikost 6/6 10 ks
sypané: 500 ks

STANDARD PACKING
retail cards: size 6/6 10 pcs
loose: 500 pcs

▶ TLOUŠŤKA MATERIÁLU 0,5 – 1,5 mm (velikost 5/6; 6/6; 7/6)	▶ THICKNESS OF MATERIAL 0,5 – 1,5 mm (size 5/6; 6/6; 7/6)
▶ ROZPÍNACÍ SILA 15 – 30 N	▶ UNBUTTON FORCE 15 – 30 N

OSTATNÍ DÍLY OTHER PARTS pérová část spring kulička ball nýt kuličky rivet



nepropustná PH vložka
watertight plastic pad

Použití

Vhodné pro textilní výrobky z materiálu GORE-TEX® jako např. ochranné oděvy určené pracovníkům ve vodohospodářství, energetice, pro vojsko, policii apod.

Poznámka

Lze kombinovat i s PH povlakem. Vhodné pro výšku vodního sloupce do 15 m.

Application

Suitable for textile products from GORE-TEX® material - as protective clothing in water-, energetic industry, forces, police etc.

Note

Possible to use with plastic coat. Suitable for the height of water column to 15 m.

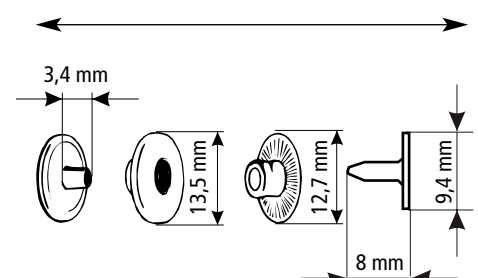



UKÁZKA BALENÍ • ILLUSTRATION OF PACKING • 1

13 KNOFLÍKY STISKACÍ NÝTOVACÍ VODOTĚSNÝ • SNAP FASTENERS WATERTIGHT



KNOFLÍKY STISKACÍ • SNAP FASTENERS •





1

z a p í n á m e c e l ý s v ě t







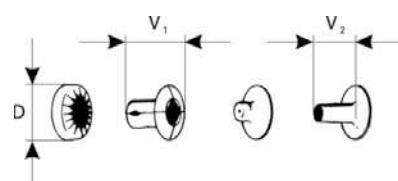

LORD

13, 14, 15 SPECIÁLNÍ APLIKACE • SPECIAL APPLICATIONS

Art.	Velikost / Size	D / V ₁ / V ₂ (mm)	Materiál / Material	► ocel / steel
			Povlak / Coat	► ocel / steel
14122		2/2 8,0/5,0/3,8	STANDARDNÍ POVRCHOVÁ ÚPRAVA nikl, barevný lak	STANDARD SURFACE FINISH nickel, colour lacquer
14132		3/2 9,7/5,0/3,8	STANDARDNÍ BALENÍ sypané: 500 ks	STANDARD PACKING loose: 500 pcs
Použití	K zapínání výrobků v papírenském a knihařském průmyslu nebo na kožené zboží.		APPLICATION For the fastening in paper industry, for leather goods.	
OSTATNÍ DÍLY OTHER PARTS				TLouŠTKA MATERIÁLU 0,5 – 1,5 mm (velikost 2/2)
			ROZPÍNACÍ SÍLA 15 – 20 N (velikost 2/2)	THICKNESS OF MATERIAL 0,5 – 1,5 mm (size 2/2)
			TLouŠTKA MATERIÁLU 0,5 – 2,0 mm (velikost 4/3)	UNBUTTON FORCE 15 – 20 N (size 2/2)
			ROZPÍNACÍ SÍLA 25 – 50 N (velikost 4/3)	THICKNESS OF MATERIAL 0,5 – 2,0 mm (size 4/3)
				UNBUTTON FORCE 25 – 50 N (size 4/3)



Art.	Velikost / Size	D / V ₁ / V ₂ (mm)	Materiál / Material	► mosaz / brass
1312P			OSTATNÍ DÍLY OTHER PARTS	STANDARDNÍ POVRCHOVÁ ÚPRAVA nikl, mosaz
				STANDARDNÍ BALENÍ sypané: 500 ks
				Použití K zapínání peněženek a podobných výrobků.
				TLouŠTKA MATERIÁLU 0,5 – 1,5 mm
				ROZPÍNACÍ SÍLA 15 – 30 N
1313P		3/2 9,7/2,1/5,4		STANDARD SURFACE FINISH nickel, brass
				STANDARD PACKING loose: 500 pcs
				APPLICATION For fastening of purses or similar product.
				THICKNESS OF MATERIAL 0,5 – 1,5 mm
				UNBUTTON FORCE 15 – 30 N

PENĚŽENKOVÝ UZÁVĚR • PURSE-CLOSURE

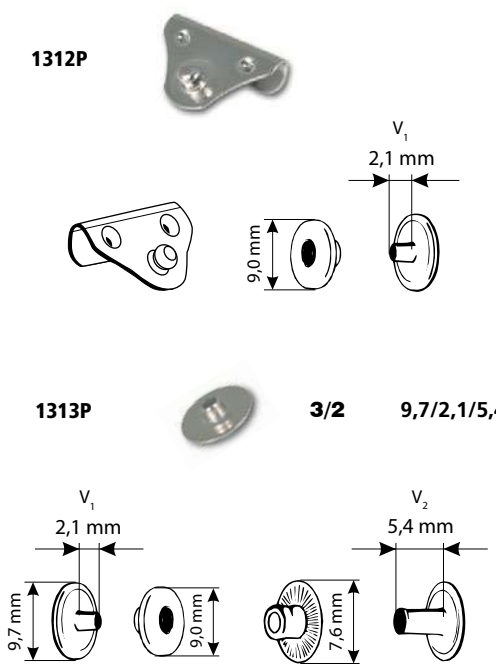

KNOFLÍKY STISKACÍ • SNAP FASTENERS •

1

z a p í n á m e c e l ý s v ě t



15 NÝTOVACÍ NA VELMI SILNÉ MATERIÁLY • FOR VERY THICK MATERIAL

Art. Velikost / Size A/B (mm) Materiál / Material mosaz / brass

KIN DOT • KIN DOT

15101

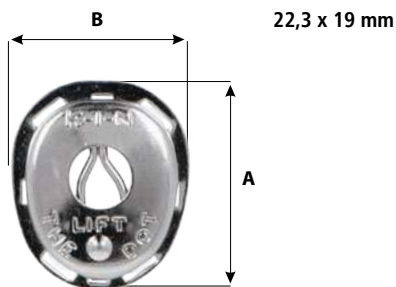

STANDARDNÍ POVRCHOVÁ ÚPRAVA
nikl, černý nikl, mosaz

STANDARDNÍ BALENÍ
MO karty: 3 ks
sypané: 100, 1000 ks

Použití
Ke spojování silných druhů látek - plachtovina, pouzdra na zbraně a nože.

TLOUŠTKA MATERIÁLU
2 - 3 mm

ROZPÍNACÍ SILA
40 - 80 N

STANDARD SURFACE FINISH
nickel, black nickel, brass

STANDARD PACKING
retail cards: 3 pcs
loose: 100, 1000 pcs

APPLICATION
Fastening of strong material - canvas, gun holsters and sheaths.

THICKNESS OF MATERIAL
2 - 3 mm

UNBUTTON FORCE
40 - 80 N

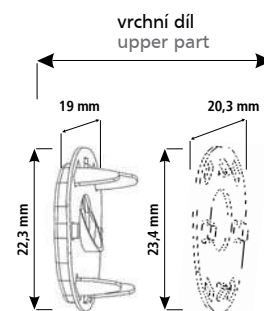

pérová část
spring

podložka pérové části
washer spring

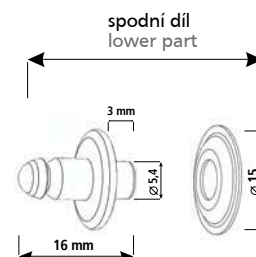

kulička
ball

podložka kuličky
washer ball

nikl
nickel

černý nikl
black nickel

mosaz
brass





UKÁZKA BALENÍ • ILLUSTRATION OF PACKING • 1

15 KNOFLÍKY STISKACÍ NÝTOVACÍ NA VELMI SILNÉ MATERIÁLY • SNAP FASTENERS FOR VERY THICK MATERIAL



KNOFLÍKY STISKACÍ • SNAP FASTENERS •

1

z a p í n á m e c e l ý s v ě t



ROLAND

16 NÝTOVACÍ S HROTY NA SLABÉ LÁTKY • FOR THIN MATERIAL

Art. Velikost / Size D / V (mm) • Materiál / Material ▶ mosaz / brass

16102
Baby



2

10/3,6

STANDARDNÍ POVRCHOVÁ ÚPRAVA
nikl free, nikl, černý nikl, mosaz, staromosaz,
barevný lak dle barevnice Barevný lak,
metalický lak dle barevnice Metalický lak,
Decor dle barevnice Nýtovací knoflíky
s hroty Roland Decor

STANDARD SURFACE FINISH
nickel free, nickel, black nickel, brass, old brass,
colour lacquer according to colour card
Colour lacquer, metallic lacquer according to
colour card Metallic lacquer, Decor according to
colour card Press buttons with tip Roland Décor

16202
Style



2

11/4,3

STANDARDNÍ BALENÍ
MO karty: dle velikosti 6, 10, 15 ks
sypané: 500, 2000 ks

STANDARD PACKING
retail cards: according to size 6, 10, 15 pcs
loose: 500, 2000 pcs

16402
Dominant



2

10,5/4,0

OSTATNÍ DÍLY
OTHER PARTS

pérová část
spring

kulička
ball

kroužek s hroty
ring with points

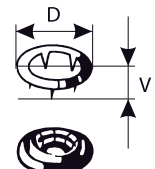

16602
Decor



2

13/5,3



16A03
Baby



3

11/4,5

pérová část
spring

kulička
ball

kroužek s hroty
ring with points



16103
Baby s nýtem
Baby with rivet



3

11/4,5



16B03
Style



3

12/5,3

PROVEDENÍ S NÝTEM • WITH RIVET

pérová část
spring

kulička
ball

nýt
rivet

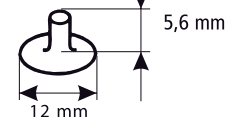

16203
Style s nýtem
Style with rivet

Použití

Ke spojování jemných a poddajných druhů látek – froté, úplety, košilovina aj.

VELIKOST 2	VELIKOST 3
TLOUŠŤKA MATERIÁLU 0,5 – 1,0 mm	TLOUŠŤKA MATERIÁLU 0,5 – 1,8 mm

ROZPÍNAČÍ SÍLA	ROZPÍNAČÍ SÍLA
10 – 25 N	10 – 30 N

Pro nýtování nabízíme ruční nebo pneumatické lisy s vyměnitelnými pistony.

Materiál není třeba předem vyděrovat, pro nýt u velikosti 3 děrování doporučujeme.

Poznámka

Na základě požadavků zákazníka jsou možné i ostatní povrchové úpravy dle katalogového listu POVRCHOVÉ ÚPRAVY. ROLAND Style může být vyráběn s rytinami dle požadavků zákazníka.

Application

Fastening of fine and flexible materials – shirting etc.

SIZE 2	SIZE 3
THICKNESS OF MATERIAL 0,5 – 1,0 mm	THICKNESS OF MATERIAL 0,5 – 1,8 mm

UNBUTTON FORCE	UNBUTTON FORCE
10 – 25 N	10 – 30 N

For riveting we offer you presses with various tools.

Not necessary to punch material, but we recommend to punch material for rivet – size 3.

Note

We can produce also another surface finishing according catalogue list FINISH SURFACE. ROLAND Style can be produced also with mint according customer's request.



UKÁZKA BALENÍ • ILLUSTRATION OF PACKING • 1

16 KNOFLÍKY STISKACÍ NÝTOVACÍ S HROTY NA SLABÉ LÁTKY • SNAP FASTENERS FOR THIN MATERIAL

ROLAND 



16112097-KV7713V-V-
724057
15ks/miska/Karta, 10kar/krabice
Spce/blister/card, 10cards/box
10x
knoflík stiskací ROLAND
Brass Press Buttons Rol
2 (ø 7mm)
nikl, nickel-plated



15x
Press fasteners for thin material
Knoflíky stiskací nýtovací na slabé látky
Druckknöpfe für dünne Stoffe
Кнопки застежки для тонких тканей

Roland Baby
Jersey

10x
Press fasteners for thin material
Knoflíky stiskací nýtovací na slabé látky
Druckknöpfe für dünne Stoffe
Кнопки застежки для тонких тканей

Roland Style
Jersey & Jeans

6x
Press fasteners for thin material
Knoflíky stiskací nýtovací na slabé látky
Druckknöpfe für dünne Stoffe
Кнопки застежки для тонких тканей

Roland Decor
Jersey & Chic

Thickness of material 0,5 - 1,0 mm • The thickness of material 0,5 - 1,0 mm

z a p í n á m e c e l ý s v ě t



21 PŘIŠÍVACÍ WILLY • SEWING WILLY

Art. Velikost / Size D (mm) Materiál / Material Zn slitina / Zn alloy

21014



14

14

STANDARDNÍ POVRCHOVÁ ÚPRAVA
nikl, nikl antik, staromosaz

STANDARD SURFACE FINISH
nickel, nickel antique, old brass

STANDARDNÍ BALENÍ
MO karty: 15 ks
sypané: 500 ks

STANDARD PACKING
retail cards: 15 pcs
loose: 500 pcs

21017



17

17

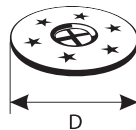

23 PRO RUČNÍ POTAHOVÁNÍ • SELF COVERED

Art. Velikost / Size D (mm) Materiál / Material nerez • plast / stainless steel • plastic

23012



12

12

STANDARDNÍ BALENÍ
MO karty: 10 ks
sypané: 500 ks

STANDARD PACKING
retail cards: 10 pcs
loose: 500 pcs

Použití
Po potažení materiálem jako běžný
přišívací knoflík.

APPLICATION
After covering with material can be used
as normal sewing button.

23015



15

15

OSTATNÍ DÍLY
OTHER PARTS

kroužek
ring

očko
eyelet



25 NESNÍMATELNÉ • UNREMOVABLE

Art. Velikost / Size D (mm) Materiál / Material ocel / steel

25017



17

17

STANDARDNÍ POVRCHOVÁ ÚPRAVA
nikl

STANDARD SURFACE FINISH
nickel

STANDARDNÍ BALENÍ
sypané: 1000 ks

STANDARD PACKING
loose: 1000 pcs

Použití
Vhodný na všechny druhy oděvů
(kůže, plachtovina, jeans).

APPLICATION
Suitable for all kind of clothes
(leather, canvas, jeans).

TLOUŠTKA MATERIÁLU
1 – 2 mm

THICKNESS OF MATERIAL
1 – 2 mm

OSTATNÍ DÍLY
OTHER PARTS

kroužek
ring

nýt
rivet

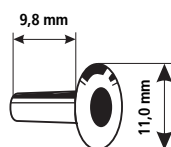
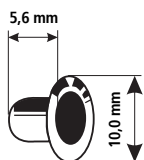
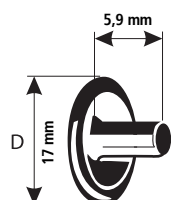



UKÁZKA BALENÍ • ILLUSTRATION OF PACKING • 2

21 KNOFLÍKY ZAPÍNACÍ PŘIŠÍVACÍ WILLY • BUTTONS SEWING WILLY



23 KNOFLÍKY ZAPÍNACÍ PRO RUČNÍ POTAHOVÁNÍ • BUTTONS SELF COVERED



z a p í n á m e c e l ý s v ě t



26 NESNÍMATELNÉ JEANSOVÉ • UNREMOVABLE JEANS

Art.	Velikost / Size	D (mm)	Materiál / Material	mosaz • plast / brass • plastic
26105	5	14	STANDARDNÍ POVRCHOVÁ ÚPRAVA nikl, černý nikl, nikl antik, mosaz, staromosaz, měď, staroměď	STANDARD SURFACE FINISH nickel, black nickel, nickel antic, brass, old brass, copper, old copper
26505 Metal	5	14	STANDARDNÍ BALENÍ MO karty: velikost 5 6 ks MO karty: velikost 7 3 ks sypané: 100, 1000 ks	STANDARD PACKING retail cards: size 5 6 pcs retail cards: size 7 3 pcs loose: 100, 1000 pcs
26107	7	17		
26507 Metal	7	17		

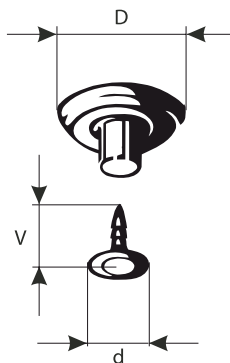

SPODNÍ DÍL	LOWER PART
MATERIÁL Zn slitina	MATERIAL Zn alloy
STANDARDNÍ POVRCHOVÁ ÚPRAVA mosaz, povlak staromosaz	STANDARD SURFACE FINISH brass, coating old brass

	d / V (mm)
špička point	7,8 / 8,3
špička s povlakem point with coating	9,0 / 8,5

Použití

K zapínání jeansových a podobných oděvů.

TLOUŠŤKA MATERIÁLU
1 – 2 mm

Pro připevňování nabízíme ruční nebo pneumatické lisy s vyměnitelnými pistony

Poznámka

Na základě požadavků zákazníka jsou možné i ostatní povrchové úpravy dle katalogového listu POVRCHOVÉ ÚPRAVY.
Ražby na svršku knoflíku jsou vyráběny dle katalogového listu RYTINY KIN nebo dle přání zákazníka.

Application

For the fastening of jeans clothes.

THICKNESS OF MATERIAL
1 – 2 mm

For riveting we offer you presses with various tool

Note

We can produce also another surface finishing according catalogue list FINISH SURFACE.
Cap can be produced also with mint according catalogue list ENGRAVINGS KIN or customer's request.



UKÁZKA BALENÍ • ILLUSTRATION OF PACKING • 2

26 KNOFLÍKY ZAPÍNAČÍ NESNÍMATELNÉ JEANSOVÉ • BUTTONS UNREMOVABLE JEANS



z a p í n á m e c e l ý s v ě t



DRESSING



27 SNÍMATELNÉ • DETACHABLE

Art. Velikost / Size D (mm) Materiál / Material plast • ocel / plastic • steel

27101



17 17

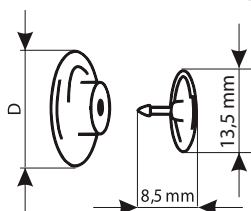

STANDARDNÍ PVRCHOVÁ ÚPRAVA
barevný plast dle barevnice Snímatelné knoflíky Dressing Color

STANDARDNÍ BALENÍ
MO karty: 10 ks
sypané: 500 ks

STANDARD SURFACE FINISH
colour plastic according to Detachable buttons Dressing Color

STANDARD PACKING
retail cards: 10 pcs
loose: 500 pcs



spodní díl • lower part

SPODNÍ DÍL LOWER PART

MATERIÁL ocel MATERIAL steel

Použití

Na pracovní oděvy, ložní prádlo apod. Připevňování se provádí ručně nebo kladivem. Špičkou spodního dílu se propíchně látka. Oba díly se stisknou k sobě.

Lze též použít ruční nebo pneumatické lisy s vyměnitelnými pistony.

TLOUŠŤKA MATERIÁLU
0,5 – 1,5 mm

Poznámka

Na základě požadavků zákazníka jsou možné i ostatní barvy plastu dle barevnice.

Application

For the working, sport and bed clothes. Fastening is made by hand or hammer. Material is punched by the point of lower part. Both parts are pressed together.

It is also possible to use pneumatic press with various tools.

THICKNESS OF MATERIAL
0,5 – 1,5 mm

Note

We can produce also another colours plastic according colour card.

SPORT



27 SNÍMATELNÉ • DETACHABLE

Art. Velikost / Size D (mm) Materiál / Material mosaz • plast / brass • plastic

27201



17 17

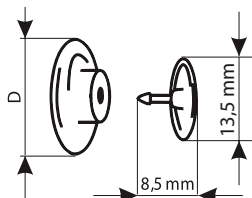

STANDARDNÍ PVRCHOVÁ ÚPRAVA
nikl, černý nikl, staromosaz

STANDARDNÍ BALENÍ
sypané: 100, 1000 ks

STANDARD SURFACE FINISH
nickel, black nickel, old brass

STANDARD PACKING
loose: 100, 1000 pcs



spodní díl • lower part

SPODNÍ DÍL LOWER PART

MATERIÁL ocel MATERIAL steel

Použití

Na pracovní, sportovní oděvy. Připevňování se provádí ručně, špičkou spodního dílu se propíchně látka. Oba díly se stisknou k sobě.

Lze též použít ruční nebo pneumatické lisy s vyměnitelnými pistony.

TLOUŠŤKA MATERIÁLU
0,5 – 1,5 mm

Poznámka

Na základě požadavků zákazníka jsou možné i ostatní povrchové úpravy dle katalogového listu PVRCHOVÉ ÚPRAVY.

Ražby na svršku knoflíku jsou vyráběny dle katalogového listu RYTINY KIN nebo dle přání zákazníka.

Application

For the working and sport clothes. Fastening is made by hand, material punched by the point of lower part. Both parts are pressed together.

It is also possible to use pneumatic press with various tools.

THICKNESS OF MATERIAL
0,5 – 1,5 mm

Note

We can produce also another surface finishing according catalogue list FINISH SURFACE.

Cap can be produced also with mint according catalogue list ENGRAVINGS KIN or customer's request.



UKÁZKA BALENÍ • ILLUSTRATION OF PACKING • 2

27 KNOFLÍKY ZAPÍNAČÍ SNÍMATELNÉ • BUTTONS DETACHABLE

DRESSING 



27 KNOFLÍKY ZAPÍNAČÍ SNÍMATELNÉ • BUTTONS DETACHABLE

SPORT 



z a p í n á m e c e l ý s v ě t



28 KALHOTOVÝ NÝT • RIVET

Art.

D / d / V (mm)

Materiál / Material ▶ mosaz / brass

PLOCHÝ • FLAT

28001



9,4/9,4/8

STANDARDNÍ POVRCHOVÁ ÚPRAVA
nikl, nikl antik, staromosaz, st. měď

STANDARDNÍ BALENÍ
MO karty: 10 ks
sypané: 1000 ks

POZNÁMKA
Standardní ražba na vrchním díle –
hvězdičky, možnost i zákaznické rytiny.

STANDARD SURFACE FINISH
nickel, nickel antique, old brass, old copper

STANDARD PACKING
retail cards: 10 pcs
loose: 1000 pcs

NOTE
Standard mint on upper part –
stars, possibility of customer's mint.

KLOBOUČKOVÝ • CONVEX

28004

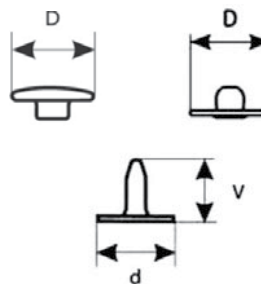

TLOUŠŤKA MATERIÁLU
1 – 4,5 mm
Pro připevňování nabízíme ruční nebo
pneumatické lisy s vyměnitelnými pistony

THICKNESS OF MATERIAL
1 – 4,5 mm
For riveting we offer you presses
with various tool

spodní díl • lower part

Použití

Ozdobný prvek jeansových a podobných oděvů.

Pro nýtování nabízíme ruční nebo pneumatické lisy s vyměnitelnými pistony. Materiál doporučujeme předem vyděrovat, u pneumatického lisu není děrování ve většině případů potřeba.

Application

Decorative item for jeans and similar clothing.

For riveting we offer you presses with various tools. We recommend to punch the material in advance, not necessary by using pneumatic press.



UKÁZKA BALENÍ • ILLUSTRATION OF PACKING • 2

28 KALHOTOVÝ NÝT • RIVET



z a p í n á m e c e l ý s v ě t



LORD



W PLACHTOVÝ KROUŽEK S PODLOŽKOU - PRŮCHODKA • STEEL SAIL RING WITH WASHER - EYELET

Art.	Velikost / Size	d / V / D (mm)	Materiál / Material
W5120	12 x 5	12/5/24	ocel / steel
W5080	8 x 6	8/6/18	ocel / steel

STANDARDNÍ POVRCHOVÁ ÚPRAVA
nikl, mosaz, staromosaz

STANDARDNÍ BALENÍ

MO karty:	10 ks
sypané:	velikost 12x5 50, 1000 ks
	velikost 8x6 100, 1000 ks

STANDARD SURFACE FINISH
nickel, brass, old brass

STANDARD PACKING

retail cards:	10 pcs
loose:	size 12x5 50, 1000 pcs
	size 8x6 100, 1000 pcs

W OBUVNÍ KROUŽEK S PODLOŽKOU - PRŮCHODKA • BRASS SHOE RING WITH WASHER - EYELET

Art.	Velikost / Size	d / V / D (mm)	Materiál / Material
W5070	7 x 5	7/5/13	mosaz / brass
W5055	5,5 x 5	5,5/5/10	mosaz / brass
W5040	4 x 5	4/5/7,5	mosaz / brass

STANDARDNÍ POVRCHOVÁ ÚPRAVA
nikl, černý nikl, mosaz, staromosaz, barevný lak dle barevnice Barevný lak

STANDARDNÍ BALENÍ

MO karty:	20 ks
sypané:	200, 1000 ks

STANDARD SURFACE FINISH
nickel, black nickel, brass, old brass, colour lacquer according to colour card Colour lacquer

STANDARD PACKING

retail cards:	20 pcs
loose:	200, 1000 pcs

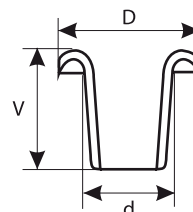

Použití

Jako průchodka pro šňůry a gumi, jako výztuž větracích otvorů.

Pro nýtování nabízíme ruční nebo pneumatické lisu s vyměnitelnými pistony.

Materiál doporučujeme předem vyděrovat, u pneumatického lisu není děrování ve většině případů potřeba.

Application

As eyelets for cords and elastics, as support of ventilate hole.

For riveting we offer you presses with various tools.

We recommend to punch the material in advance, not necessary by using pneumatic press.



UKÁZKA BALENÍ • ILLUSTRATION OF PACKING • 3

W PRŮCHODKY S PODLOŽKOU • EYELETS WITH WASHERS





30 HÁČKY A OČKA • HOOKS AND EYES

Art.	Velikost / Size	L / L ₁ (mm)
30020	4/0	20/18
30018	2/0	18/16
30015	1	15/14
30013	3	13/12
30012	4	12/10
30010	6	10/8

• Materiál / Material ▶ ocel / steel

STANDARDNÍ POVRCHOVÁ ÚPRAVA
nikl, nikl free, černý lak, mosaz

STANDARDNÍ BALENÍ
MO karty: dle velikosti 6, 12, 18 ks
sypané: dle velikosti 100, 1000, 2000, 5000 ks

STANDARD SURFACE FINISH
nickel, nickel free, black laquer, brass

STANDARD PACKING
retail cards: according to size 6, 12, 18 pcs
loose: according to size 100, 1000, 2000, 5000 pcs

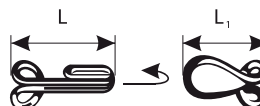

3B HÁČKY A OČKA • HOOKS AND EYES

Art.	Velikost / Size	L / L ₁ (mm)
3B010	6	10/8

• Materiál / Material ▶ mosaz / brass

STANDARDNÍ POVRCHOVÁ ÚPRAVA
barevný lak bílý (1950)

STANDARDNÍ BALENÍ
MO karty: 12 ks
sypané: 100 ks

STANDARD SURFACE FINISH
color lacquer white (1950)

STANDARD PACKING
retail cards: 12 pcs
loose: 100 pcs



31 KALHOTOVÁ SPÍNADLA • TROUSER HOOKS

Art. | A / B (mm) | Materiál / Material ▶ ocel / steel

31001
DOT

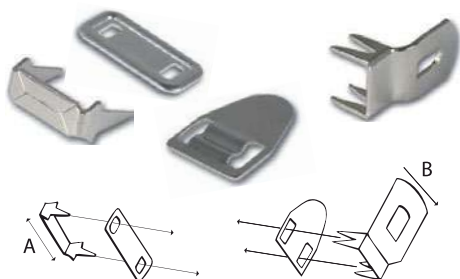

12,4/9,4

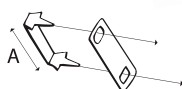

očko + podložka
eyelet + washer

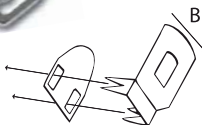

podložka + háček
washer + hook

STANDARDNÍ POVRCHOVÁ ÚPRAVA
nikl, zinek, dělová bronz

STANDARDNÍ BALENÍ
sypané: 500, 1000 ks

STANDARD SURFACE FINISH
nickel, zinc, gunmetal

STANDARD PACKING
loose: 500, 1000 pcs

31 KALHOTOVÁ SPÍNADLA • TROUSER HOOKS

Art. | A / B (mm) | Materiál / Material ▶ ocel / steel

31011
KIN



14,5/11,9

STANDARDNÍ POVRCHOVÁ ÚPRAVA
nikl, zinek

STANDARDNÍ BALENÍ
sypané: 500, 1000 ks

STANDARD SURFACE FINISH
nickel, zinc

STANDARD PACKING
loose: 500, 1000 pcs

31012
KIN
s krycí
podložkou
cover pad



14,5/11,9

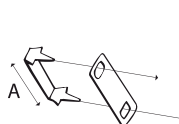

očko + podložka
eyelet + washer

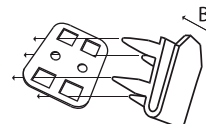

podložka + háček
washer + hook

31 SUKŇOVÁ SPÍNADLA • SKIRT HOOKS

Art. | A / B (mm) | Materiál / Material ▶ ocel / steel

31021



12,4/9,4

STANDARDNÍ POVRCHOVÁ ÚPRAVA
nikl, zinek

STANDARDNÍ BALENÍ
sypané: 500, 1000 ks

STANDARD SURFACE FINISH
nickel, zinc

STANDARD PACKING
loose: 500, 1000 pcs

Použití

V oděvním průmyslu jako spínadla oděvních výrobků, dámských a pánských kalhot apod.

Pro připevňování nabízíme ruční nebo pneumatické lisy s vyměnitelnými pistony.

Application

Clothing closure in clothing industry.

For riveting we offer you presses with various tools.

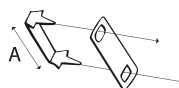

očko + podložka
eyelet + washer

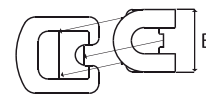

podložka + háček
washer + hook



UKÁZKA BALENÍ • ILLUSTRATION OF PACKING • 3

30 HÁČKY A OČKA • HOOKS AND EYES



z a p í n á m e c e l ý s v ě t



3A KALHOTOVÉ HÁKY NÝTOVACÍ • TROUSER HOOKS, RIVETING

Art. Velikost / Size D (mm) Materiál / Material mosaz / brass

3A013 5 13,5



STANDARDNÍ POVRCHOVÁ ÚPRAVA
nikl, černý nikl

STANDARD SURFACE FINISH
nickel, black nickel

STANDARDNÍ BALENÍ

MO karty: velikost 5/6, 6/6 5 ks
sypané: velikost 5/6 500 ks
 velikost 6/6 500 ks

STANDARD PACKING

retail cards: size 5/6, 6/6 5 pcs
loose: size 5/6 500 pcs
 size 6/6 500 pcs

3A015 6 15



OSTATNÍ DÍLY
OTHER PARTS

očko
eyelet

háček
hook

nýt očka
rivet

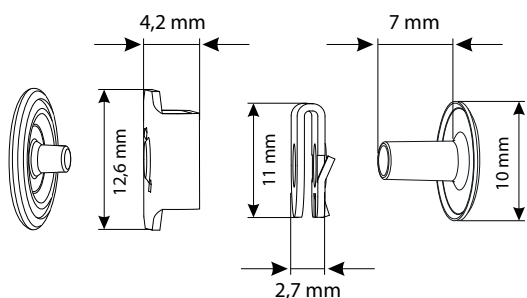

TLOUŠTKA MATERIÁLU
0,7 - 2,0 mm

THICKNESS OF MATERIAL
0,7 - 2,0 mm

PROVEDENÍ PRO MALOOBCHODNÍ KARTY • DESIGN FOR RETAIL CARDS

3A002 Ø15 mm vrchní díl upper part očko eyelet háček hook Ø13 mm vrchní díl upper part



možnost záměny
interchangeable

Použití

Jako spínadla sportovních a dětských oděvů.

Poznámka

Pro nýtování nabízíme ruční nebo pneumatické lisy s vyměnitelnými pistony.

Application

For fastening sports and children's clothing.

Note

For riveting we offer you presses with various tools.



z a p í n á m e c e l ý s v ě t



CAVALIER



32 ŠLOVÉ SOUČÁSTI • BRACE ACCESSORIES

Art. Velikost / Size L (mm) • Materiál / Material ▶ ocel • plast / steel • plastic

ŠLOVÉ ZÁVĚSY • BRACE CLIPS



STANDARDNÍ POVRCHOVÁ ÚPRAVA
nikl, plast čelisti – bílý, černý

STANDARDNÍ BALENÍ
MO karty: 2 páry, sada se šlovými přezkami
sypané: 100 ks

Použití
Pro mechanické připevňování šlí k oděvu.

STANDARD SURFACE FINISH
nickel, clip plastic – white, black

STANDARD PACKING
retail cards: 2 pairs, set with brace buckles
loose: 100 pcs

Application
For mechanical fastening.



bílé čelisti
white clip



černé čelisti
black clip





CAVALIER



32 ŠLOVÉ SOUČÁSTI • BRACE ACCESSORIES

Art. | Art. | Velikost / Size | L (mm) | • Materiál / Material ▶ ocel • plast / steel • plastic

ŠLOVÉ ZÁVĚSY (KLOPNA ŠIROKÁ)
BRACE CLIPS (WIDE SHAPE)



50 50



40 40



36 36



30 30



24 24



20 20

STANDARDNÍ POVRCHOVÁ ÚPRAVA
nikl, plast čelisti – bílý, černý

STANDARDNÍ BALENÍ
sypané: 100 ks

Použití
Pro mechanické připevňování šlí k oděvu.

STANDARD SURFACE FINISH
nickel, clip plastic – white, black

STANDARD PACKING
loose: 100 pcs

Application
For mechanical fastening.

POZNÁMKA
Ražby R1, R3 a jsou vyráběny pro všechny velikosti šlových závěsů.

NOTE
Mints R1, R3 and for brace clips are produced for all sizes.

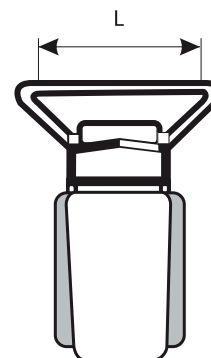
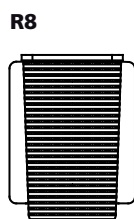
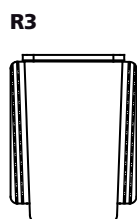
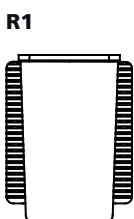



32 ŠLOVÉ SOUČÁSTI • BRACE ACCESSORIES

Art. Velikost / Size L (mm) • Materiál / Material ▶ ocel • steel

ŠLOVÉ PŘEZKY • BRACE BUCKLES

32350		50	50
32340		40	40
32336		36	36
32330		30	30
32324		24	24
32320		20	20

STANDARDNÍ POVRCHOVÁ ÚPRAVA
nikl

STANDARDNÍ BALENÍ
sypané: 100 ks

Použití
K regulaci délky šlí.

STANDARD SURFACE FINISH
nickel

STANDARD PACKING
loose: 100 pcs

Application
For braces length regulation.



ŠLOVÉ PŘEZKY (KLOPNA OVÁLNÁ) • BRACE BUCKLES (OVAL UPPER PART)

32430		30	30
32424		24	24
32420		20	20

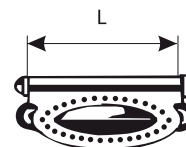

z a p í n á m e c e l ý s v ě t









CAVALIER



32 ŠLOVÉ SOUČÁSTI • BRACE ACCESSORIES

Art. Velikost / Size L (mm) • Materiál / Material ▶ ocel • steel

ŠLOVÉ TROJÚHELNÍKY • BRACE FITTINGS

32250		50	50
32240		40	40
32236		36	36
32230		30	30
32224		24	24
32220		20	20

▶
STANDARDNÍ POVRCHOVÁ ÚPRAVA
nikel

STANDARDNÍ BALENÍ
sypané: 100 ks

Použití
Spojuje šlové gummy.

▶
STANDARD SURFACE FINISH
nickel

STANDARD PACKING
loose: 100 pcs

APPLICATION
Put together elastics of braces.

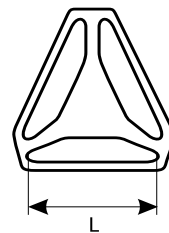



UKÁZKA BALENÍ • ILLUSTRATION OF PACKING • 3

32 ŠLOVÉ SOUČÁSTI • BRACE ACCESSORIES

CAVALIER



z a p í n á m e c e l ý s v ě t



CAVALIER

33 DROBNÉ KOVOVÉ VÝROBKY • SMALL METAL GOODS

Art.	Velikost / Size	L (mm)	Materiál / Material	ocel
PODVAZKOVÉ DRŽÁKY • SUSPENDERS WITH RIBBON				
33125		25	25	<p>▶</p> <p>STANDARDNÍ POVRCHOVÁ ÚPRAVA zinek, stuha - bílá, černá, béžová (tělová)</p> <p>STANDARDNÍ BALENÍ sypané: 100 ks</p>
33118		18	18	<p>▶</p> <p>STANDARD SURFACE FINISH zinc, ribbon - white, black, beige</p> <p>STANDARD PACKING loose: 100 pcs</p>
bílá white	černá black	béžová beige		

Art.	Velikost / Size	V (mm)	Materiál / Material	Zn slitina
PLAVKOVÉ ZAPÍNÁNÍ • BIKINI CLASPS				
33220		20	20	<p>▶</p> <p>STANDARDNÍ POVRCHOVÁ ÚPRAVA nikl free, mosaz</p> <p>STANDARDNÍ BALENÍ MO karty: 3 páry sypané: 100, 1000 páry</p> <p>Použití V oděvním průmyslu jako spínadla oděvních výrobků např. plavek apod.</p>
33215		15	15	<p>▶</p> <p>STANDARD SURFACE FINISH nickel free, brass</p> <p>STANDARD PACKING retail cards: 3 páry loose: 100, 1000 páry</p>
33210		10	10	<p>APPLICATION Clothing closure in clothing industry for example swimsuits etc.</p>
nikl free nickel free	mosaz brass			



UKÁZKA BALENÍ • 3 ILLUSTRATION OF PACKING • 3

33 PLAVKOVÉ ZAPÍNÁNÍ • BIKINI CLASPS

CAVALIER





33 DROBNÉ KOVOVÉ VÝROBKY • SMALL METAL GOODS

Art.

Velikost / Size

• Materiál / Material

▶ ocel / steel

KRAVATOVÉ KOVÁNÍ • TIE FITTINGS

33610



10

kroužek • circle háček • hook posunovač • pusher

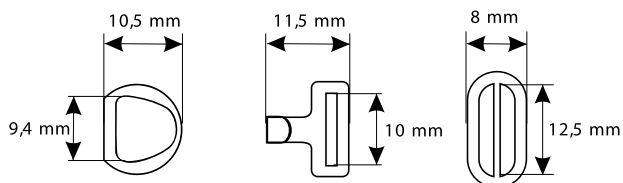

▶
STANDARDNÍ POVRCHOVÁ ÚPRAVA
nikl

STANDARDNÍ BALENÍ
MO karty: 3 ks
sypané: 50, 1000 ks

Použití
Součásti určené k připevňování motýlků a kravat.

▶
STANDARD SURFACE FINISH
nickel

STANDARD PACKING
retail cards: 3 pcs
loose: 50, 1000 pcs

Application
Parts for bow and tie fastening.

Art.

Velikost / Size

• Materiál / Material

▶ ocel / steel

PÁNSKÉ PODVAZKY • MEN SUSPENDERS

33424



24

kroužek • circle háček • hook posunovač • pusher

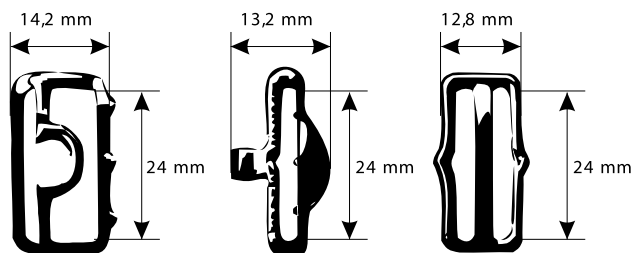

▶
STANDARDNÍ POVRCHOVÁ ÚPRAVA
nikl

STANDARDNÍ BALENÍ
sypané: 100, 1000 ks

Použití
Součásti určené k připevňování pánských podvazků na nohu.

▶
STANDARD SURFACE FINISH
nickel

STANDARD PACKING
loose: 100, 1000 pcs

Application
Parts for men suspender fastening.

z a p í n á m e c e l ý s v ě t



BON AMI



36 NÁPRSTKY • THIMBLES

Art. Velikost / Size D (mm) Art. Velikost / Size D (mm) • Materiál / Material ► ocel / steel

SE DNEM • WITH BOTTOM

BEZ DNA • BOTTOMLESS



STANDARDNÍ POVRCHOVÁ ÚPRAVA
nikl

STANDARDNÍ BALENÍ

MO karty: 1 ks

sypané: 1 celek = 144 ks

sdružené: 1 celek = 144 ks

Použití

Slouží jako ochrana prstu při ručním šití.

STANDARD SURFACE FINISH
nickel

STANDARD PACKING

retail cards: 1 pcs

loose: 1 gross = 144 pcs

assorted: 1 gross = 144 pcs

APPLICATION

Finger protection at hand sewing.



UKÁZKA BALENÍ • 3 ILLUSTRATION OF PACKING • 3

36 NÁPRSTKY • THIMBLES

BON AMI 



z a p í n á m e c e l ý s v ě t



37 VLASOVÉ SPONY • HAIR PINS

Art.	Velikost / Size	L (mm)	Materiál / Material	ocel / steel
37070		7 70		
37060		6 60		
37050		5 50		
nikl nickel				
černý lak black lacquer				
blond lak blond lacquer				

STANDARDNÍ POVRCHOVÁ ÚPRAVA
nikl, černý lak, blond lak

STANDARDNÍ BALENÍ
MO svazky: 10 ks
MO karty: 10, 12 ks
sypané: 1000 ks

Použití
Výrobky určené k úpravě vlasů.

STANDARD SURFACE FINISH
nickel, black lacquer, blond lacquer

STANDARD PACKING
retail bunches: 10 pcs
retail cards: 12 pcs
loose: 1000 pcs

APPLICATION
Products for hair styling.

38 ZÁVLAČKY • SPLIT PINS

Art.	L (mm)	Materiál / Material	ocel / steel
38012	120		
38010	100		
38001 bez nitě without thread			

STANDARDNÍ POVRCHOVÁ ÚPRAVA
nikl

STANDARDNÍ BALENÍ
sypané: 1000 ks
bez nitě 5000 ks

Použití
Jako součást k zavěšování cenovek.

STANDARD SURFACE FINISH
nickel

STANDARD PACKING
loose: 1000 pcs
without thread 5000 pcs

APPLICATION
As part of price label hanging.

L = délka nitě
L = thread length

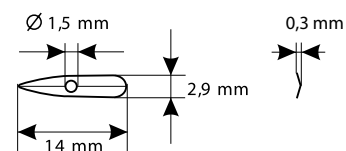



UKÁZKA BALENÍ • ILLUSTRATION OF PACKING • 3

37 VLASOVÉ SPONY • HAIR PINS

VIOLA



z a p í n á m e c e l ý s v ě t



34 KONCOVKA PLASTOVÁ S VÍČKEM • PLASTIC CORD END WITH A CAP

Art.

L (mm)

• Materiál / Material ▶ plast / plastic

34401



12

STANDARDNÍ BALENÍ

MO karty: 4 ks
sypané: 500 ks

Použití

Koncovka na šňůrky na oděvy.

STANDARD PACKING

retail cards: 4 pcs
loose: 500 pcs

APPLICATION

Used for ending cords on various types of clothing.



9005

6028

3001

1918

1016

9003

1015

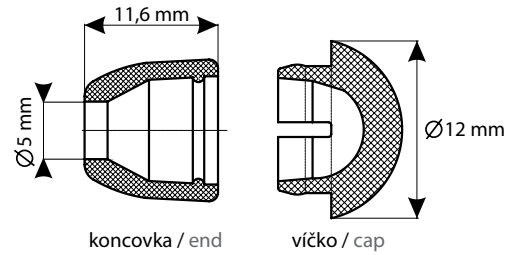

koncovka / end

víčko / cap

z a p í n á m e c e l ý s v ě t



40 NÝTY TAŽENÉ • DRAWNED RIVETS

Art.	d / V / D (mm)
OTEVŘENÉ • OPEN	
4010100	3,0/5,0/5,0
4010200	3,1/6,8/7,3
40A0101	3,7/6,4/6,3
40A0201	3,6/8,0/6,3
40A0301	3,9/5,3/5,4
4010700	4,0/3,0/6,0
4010800	3,9/4,8/6,0
4010900	4,0/5,0/7,0
4011100	4,0/6,0/7,0
4020100	4,4/6,1/9,0



• Materiál / Material ▶ ocel / steel

▶
STANDARDNÍ POVRCHOVÁ ÚPRAVA
nikl, černý nikl, zinek, mosaz, barevný lak
dle barevnice Barevný lak

STANDARDNÍ BALENÍ
sypané: 5000, 15000 ks

▶
STANDARD SURFACE FINISH
nickel, black nickel, zinc, brass, colour lacquer
according to colour card Colour lacquer

STANDARD PACKING
loose: 5000, 15000 pcs

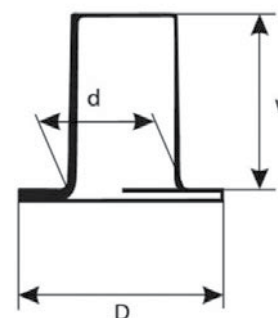

• Materiál / Material ▶ mosaz / brass

Individuální rozměry na dotaz

Individual dimensions on request

Art. | d / V / D (mm) | • Materiál / Material ▶ ocel / steel

UZAVŘENÉ • CLOSED

4040100	3,4/7,1/8,4
4040200	3,4/8,7/7,0
4040300	3,4/8,7/8,4
4040400	3,5/6,7/7,0

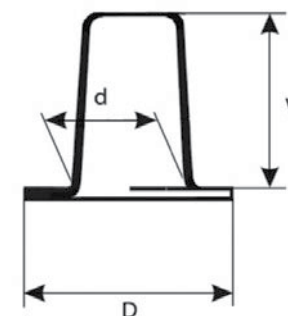

Individuální rozměry na dotaz

Individual dimensions on request

z a p í n á m e c e l ý s v ě t



40 NÝTY TAŽENÉ • DRAWNED RIVETS

Art.	d (d ₁) / V / D (mm)	• Materiál / Material ▶ ocel / steel
S POVLAKEM • WITH COATING		
40A0100	3,6/6,0/7,0	<p>STANDARDNÍ POVRCHOVÁ ÚPRAVA nikl, černý nikl, zinek, mosaz</p> <p>STANDARDNÍ BALENÍ sypané: 5000, 15000 ks</p>
40A0200	3,6x7,5x7,0	<p>STANDARD SURFACE FINISH nickel, black nickel, zinc, brass</p> <p>STANDARD PACKING loose: 5000, 15000 ks</p>
40A0300	3,9/5,0/6,0	
40A0400	3,9/6,0/6,0	
40A0500	3,0(3,9)/7,4/6,0	

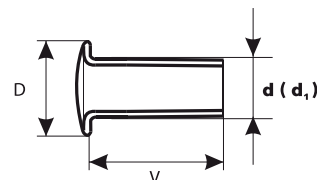

43 NÝTY KOVANÉ • FORGED RIVETS

Art.	d (d ₁) / V / D (mm)	• Materiál / Material ▶ ocel / steel
4300400	2,15/6,9/5,5	<p>STANDARDNÍ POVRCHOVÁ ÚPRAVA mosaz, zinek, odmaštění</p> <p>STANDARDNÍ BALENÍ sypané: 5 000, 50 000 ks</p>
4300500	2,15/7,2/5,5	
4300300	2,15/6,75/5,5	<p>STANDARD SURFACE FINISH brass, zinc, degreased</p> <p>STANDARD PACKING loose: 5 000, 50 000 pcs</p>
4300100	2,15/4,0/4,9	
4300200	2,15/4,6/4,9	

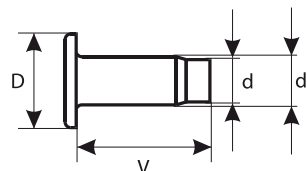

Individuální rozměry na dotaz

Individual dimensions on request

z a p í n á m e c e l ý s v ě t



44 PLACHTOVÉ DÍLY • CANVAS PARTS

Art. | Velikost / Size | d / V / D (mm) | • Materiál / Material ▶ mosaz / brass

4400102
kroužek
circle



349 5,5/4,5/13,3

4400101
podložka
washer



349 5,8/0,5/12,6

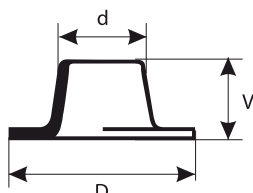

STANDARDNÍ POVRCHOVÁ ÚPRAVA
nikl, černý nikl

STANDARDNÍ BALENÍ
sypané: 200 ks

TLOUŠTKA MATERIÁLU
0,3 – 4,0 mm

Použití
Jako průchodka pro šňůry u silnějších a pevnějších materiálů jako plachtovina, koženka apod.

STANDARD SURFACE FINISH
nickel, black nickel

STANDARD PACKING
loose: 200 pcs

THICKNESS OF MATERIAL:
0,3 – 4,0 mm

APPLICATION
As eyelets for cords for more strong and firm materials (canvas etc.).

45 KROUŽEK POŘADAČE HŘBETNÍ • EYELETS FOR BINDING

Art. | Materiál / Material ▶ ocel / steel

4500100

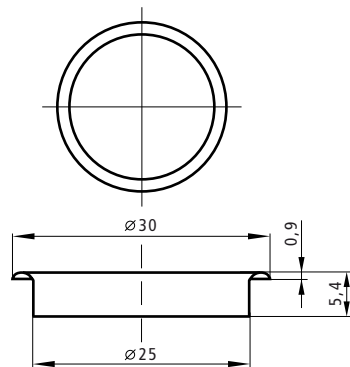

STANDARDNÍ POVRCHOVÁ ÚPRAVA
nikl

STANDARDNÍ BALENÍ
sypané: 10000 ks

STANDARD SURFACE FINISH
nickel

STANDARD PACKING
loose: 10000 pcs

45 KROUŽEK POŘADAČE OVÁLNÝ • OVAL EYELETS FOR BINDING

Art. | Materiál / Material ▶ ocel / steel

4500200

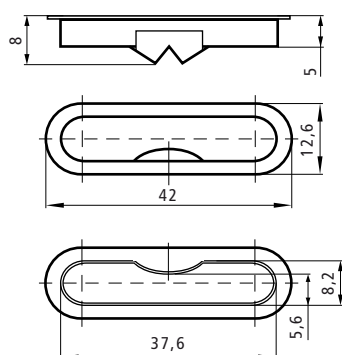

STANDARDNÍ POVRCHOVÁ ÚPRAVA
nikl

STANDARDNÍ BALENÍ
sypané: 10000 ks

STANDARD SURFACE FINISH
nickel

STANDARD PACKING
loose: 10000 pcs

z a p í n á m e c e l ý s v ě t



47 OSTATNÍ SVORKY A SPONY • OTHER GRIPS AND CLASPS

Art.

• Materiál / Material ▶ Zn slitina • pryž / Zn alloy • india - rubber

SPOJOVACÍ PRVEK QUICK • CONNECTING PARTS QUICK

4780100



pryž • india - rubber

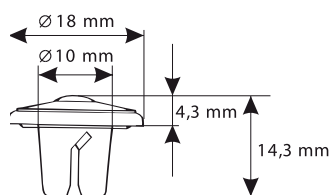
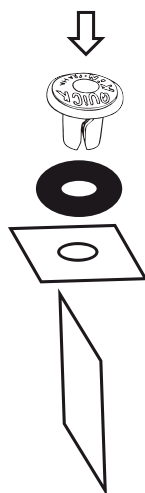

STANDARDNÍ BALENÍ	
sypané:	100, 500 ks
Použití	
Ke spojování plechů při stavbě potrubí, zejména ve vzduchotechnice.	
tloušťka materiálu: 0,6 – 1,0 mm	
POZNÁMKA	
Na přírubě spojky lze vyrobit ražbu dle požadavku zákazníka.	
STANDARD PACKING	
loose:	100, 500 pcs
APPLICATION	
For sheets connection in air industry, building of pipeline.	
thicknes of material: 0,6 – 1,0 mm	
NOTE	
Can be delivered with customer's mint.	

48 HŘEBÍČKY IXA • IXA NAILS

Art.

Velikost / Size

L / d (mm)

• Materiál / Material ▶ kalená ocel / hard steel

4823000



30

30/1,20

4822500



25

25/1,20

4822300



23

23/1,20

STANDARDNÍ POVRCHOVÁ ÚPRAVA	
nikl, odmaštění	
STANDARDNÍ BALENÍ	
sypané:	1000 ks
Použití	
K připevňování drobných předmětů jako obrazových háčků na dřevo, hobru, omítku apod.	
STANDARD SURFACE FINISH	
nickel, degreased	
STANDARD PACKING	
loose:	1000 pcs
APPLICATION	
Connection of tiny products from wood, plaster etc.	
L = délka hřebíčku / nail length	
d = Ø drátu / wire diameter	

Individuální rozměry na dotaz

Individual dimensions on request

ŠPENDLÍKY NAPICHOVACÍ • STRAIGHT PINS •

5

z a p í n á m e c e l ý s v ě t



50 OCEL MĚKKÁ • MILD STEEL

Art.	Velikost / Size	L / d / D (mm)
50038		38 38/1,05/2,00
50107		107 34/1,00/1,90
50105		105 30/0,85/1,70
50103		103 26/0,80/1,60
50101		101 22/0,70/1,50
50100		100 20/0,65/1,40
50099		99 18/0,65/1,40
50016		16 16/0,65/1,60
50014		14 14/0,60/1,60

• Materiál / Material ► ocel / steel

▶
STANDARDNÍ POVRCHOVÁ ÚPRAVA
nikl, mosaz, černý lak

STANDARDNÍ BALENÍ
MO závěsné krabičky: 15, 25, 50 g
MO krabičky: 25, 50, 100 g
sypané: 0,5, 1 kg

▶
STANDARD SURFACE FINISH
nickel, brass, black lacquer

STANDARD PACKING
retail hanging box 15, 25, 50 g
retail box: 25, 50, 100 g
loose: 0,5, 1 kg

L = délka špendlíku / pin length
d = \varnothing drátu / wire diameter
D = \varnothing hlavy / head diameter

51 OCEL MĚKKÁ - TENKÉ • MILD STEEL - THIN

Art.	Velikost / Size	L / d / D (mm)
51207		207 35/0,80/1,60
51206		206 32/0,70/1,50
51205		205 30/0,65/1,40
51200		200 30/0,60/1,40
51204		204 26/0,65/1,40
51202		202 26/0,60/1,30

▶
STANDARDNÍ POVRCHOVÁ ÚPRAVA
nikl, černý lak, mosaz

STANDARDNÍ BALENÍ
MO závěsné krabičky: 15, 25, 50 g
MO krabičky: 25, 50 g
sypané: 0,5, 1 kg

▶
STANDARD SURFACE FINISH
nickel, black lacquer, brass

STANDARD PACKING
retail hanging box: 15, 25, 50 g
retail box: 25, 50 g
loose: 0,5, 1 kg

L = délka špendlíku / pin length
d = \varnothing drátu / wire diameter
D = \varnothing hlavy / head diameter

ŠPENDLÍKY NAPICHOVACÍ • STRAIGHT PINS •

5

z a p í n á m e c e l ý s v ě t



RIVAL

51 OCEL MĚKKÁ – TENKÉ • MILD STEEL – THIN

Art.	Velikost / Size	L / d / D (mm)	Materiál / Material
VELKÁ HLAVA • BIG HEAD			
51051		51 51/1,20/2,70	<p>STANDARDNÍ POVRCHOVÁ ÚPRAVA nikl, černý lak, mosaz</p> <p>STANDARDNÍ BALENÍ MO závěsné krabičky: 15, 25, 50 g MO krabičky: 25, 50 g sypané: 0,5, 1 kg</p> <hr/> <p>STANDARD SURFACE FINISH nickel, black lacquer, brass</p> <p>STANDARD PACKING retail hanging box: 15, 25, 50 g retail box: 25, 50 g loose: 0,5, 1 kg</p> <hr/> <p>L = délka špendlíku / pin length d = \varnothing drátu / wire diameter D = \varnothing hlavy / head diameter</p>
51038		38 38/1,20/2,60	
51219		219 38/0,90/2,20	
51217		217 35/0,80/2,10	
51034		34 34/0,60/1,60	
51216		216 32/0,70/1,90	
51214		214 27/0,65/1,80	
51027		27 27/0,70/1,85	
51026		26 26/0,95/2,35	
51213		213 18/0,65/1,80	

52 OCEL KALENÁ • HARD STEEL

Art.	Velikost / Size	L / d / D (mm)	Materiál / Material
52085	F	8,5 37/0,70/1,70	<p>STANDARDNÍ POVRCHOVÁ ÚPRAVA nikl</p> <p>STANDARDNÍ BALENÍ MO závěsné krabičky: 15, 25, 50 g MO krabičky: 25, 50 g sypané: 0,5 kg</p> <hr/> <p>STANDARD SURFACE FINISH nickel</p> <p>STANDARD PACKING retail hanging box: 15, 25, 50 g retail box: 25, 50 g loose: 0,5 kg</p> <hr/> <p>L = délka špendlíku / pin length d = \varnothing drátu / wire diameter D = \varnothing hlavy / head diameter EF = extra tenké / extra fine SF = super tenké / super fine F = tenké / fine</p>
52034	EF	34 34/0,60/1,60	
52070	F	7 32/0,70/1,70	
52065	EF	6,5 32/0,60/1,60	
52060	EF	6 30/0,60/1,60	
52055	SF	5,5 30/0,55/1,50	
52045	SF	4,5 30/0,50/1,35	
52026	EF	26 26/0,60/1,60	

ŠPENDLÍKY NAPICHOVACÍ • STRAIGHT PINS •

5

z a p í n á m e c e l ý s v ě t



RIVAL

53 MOSAZNÉ • BRASS

Art.	Velikost / Size	L / d / D (mm)	Materiál / Material
53107		107 34/1,00/1,90	MOSAZ / BRASS ▶ STANDARDNÍ POVRCHOVÁ ÚPRAVA nikl, mosaz <hr/> STANDARDNÍ BALENÍ MO závěsné krabičky: 15, 25, 50 g MO krabičky: 25, 50 g sypané: 0,5 kg <hr/> STANDARD SURFACE FINISH nickel, brass <hr/> STANDARD PACKING retail hanging box: 15, 25, 50 g retail box: 25, 50 g loose: 0,5 kg
53105		105 30/0,85/1,70	
53026		26 26/0,65/1,50	
53102		102 24/0,65/1,50	
53101		101 22/0,65/1,50	
53099		99 18/0,60/1,40	
53197		14 14/0,60/1,60	
53193		193 10/0,55/1,30	

W SPECIÁLNÍ • SPECIAL

Art.	Velikost / Size	L / d (mm)	Materiál / Material
SKLENĚNÁ HLAVA • WITH GLASS HEAD			
W2102		38 38/0,60	KALENÁ OCEL / HARD STEEL ▶ STANDARDNÍ POVRCHOVÁ ÚPRAVA nikl, barevná hlava <hr/> STANDARDNÍ BALENÍ MO karty: 50, 100 ks MO závěsné krabičky: 80, 100 ks sypané: 500, 1000 ks <hr/> STANDARD SURFACE FINISH nickel, colourful <hr/> STANDARD PACKING retail cards: 50, 100 pcs retail hanging box: 80, 100 pcs loose: 500, 1000 pcs
W2101		31 31/0,60	
W2101		31 31/0,60	
W2103		30 30/0,55	

Art.	Velikost / Size	L / d (mm)	Materiál / Material
PLASTOVÁ HLAVA • WITH PLASTIC HEAD			
W2005		31 30/0,60	KALENÁ OCEL / HARD STEEL ▶ STANDARDNÍ POVRCHOVÁ ÚPRAVA nikl, barevná hlava <hr/> STANDARDNÍ BALENÍ MO karty: 50, 100 ks MO závěsné krabičky: 50, 100 ks sypané: 500 ks <hr/> STANDARD SURFACE FINISH nickel, colourful <hr/> STANDARD PACKING retail cards: 50, 100 pcs retail hanging box: 50, 100 pcs loose: 500 pcs <hr/> MATERIÁL / MATERIAL ▶ ocel / steel
L = délka špendlíku / pin length d = Ø drátu / wire diameter D = Ø hlavy / head diameter			
W2004		38 38/0,60	
W2003		33 33/0,60	
W2003		33 33/0,60	
W2002		31 31/0,60	
W2001		28 27/0,60	

přírodní lesk
natural shine



perleť
pearl



neon
neon





UKÁZKA BALENÍ • 5 ILLUSTRATION OF PACKING • 5



50 ŠPENDLÍKY NAPICHOVACÍ • STRAIGHT PINS



STANDARDNÍ BALENÍ

MO KARTY

- C** pl.ph/ karta,
karta s plochou krabičkou s eurozávěsem

MO ZÁVĚSNÉ KRABIČKY

- F** ph.kr0, kulatá krabička s eurozávěsem
- I** ph.kr8-eurozávěs,
osmiboká krabička s eurozávěsem

MO KRABIČKY

- B** krabice (25g, 50g), krabička potištěná
- D** ph.kr8, osmiboká krabička
- E** ph.kr8/hou, osmiboká krabička s houbičkou
- G** ph.kr, „citronka“ krabička

ŠYPANÉ

- A** krabice (250g, 500g)
- H** krabice (500g, 1000g)

STANDARD PACKING

RETAIL CARDS

- C** flat plastic box/card, with euroslot

RETAIL HANGING BOXES

- F** round plastic box, with euroslot
- I** octagonal box with euroslot

RETAIL BOXES

- B** box (25g, 50g)
- D** octagonal box
- E** octagonal box with sponge
- G** squared plastic box

LOOSE

- A** box (250g, 500g)
- H** box (500g, 1000g)











ŠPENDLÍKY SPÍNACÍ • SAFETY PINS •

5

z a p í n á m e c e l ý s v ě t



55 DUPLEX • DUPLEX

Art.	Velikost / Size	L / d (mm)	Materiál / Material	ocel / steel
55060		5 60/1,30	<p>▶</p> <p>STANDARDNÍ POUZITÍ nikl, mosaz, černý lak, barevný lak dle barevnice Barevný lak</p>	
55055		4 55/1,10	<p>STANDARDNÍ BALENÍ MO svazky: 12 ks MO karty: dle velikosti 6, 12, 18 ks sypané: 1000 ks 12 celků (1 celek = 144 ks)</p>	
55050		3 50/1,10	<p>sdružené: MO svazky: velikosti 1, 2, 3 12 ks MO karty: velikosti 1, 2, 3 12 ks MO karty: velikosti 3/0 - 5 18 ks + 1 Zdarma</p>	
55048		2 3/4 48/1,00	<p>▶</p> <p>STANDARD SURFACE FINISH nickel, brass, black lacquer, colour lacquer according to colour card Colour lacquer</p>	
55045		2 1/2 45/0,95	<p>STANDARD PACKING retail bunches: 12 pcs retail cards: according to size 6, 12, 18 pcs loose: 1000 ks 12 gross (1 gross = 144 pcs)</p>	
55040		2 40/0,95	<p>assorted: retail bunches: size 1, 2, 3 12 pcs retail cards: size 1, 2, 3 12 pcs retail cards: size 3/0 - 5 18 pcs + 1 Free</p>	
55034		1 1/2 34/0,80		
55028		1 28/0,80		
55022		2/0 22/0,70	<p>L = délka špendlíku / pin length d = ø drátu / wire diameter</p>	
55019		3/0 19/0,67		

ŠPENDLÍKY SPÍNACÍ • SAFETY PINS

5

z a p í n á m e c e l ý s v ě t



DUPLEX Color

55 DUPLEX - BAREVNÉ • DUPLEX - COLOR

Art.	Velikost / Size	L / d (mm)	Materiál / Material
55028/A1		1 28/0,80	ocel / steel
55028/A2		1 28/0,80	ocel / steel
55028/A3		1 28/0,80	ocel / steel
55028/A4		1 28/0,80	ocel / steel
55028/A5		1 28/0,80	ocel / steel

STANDARDNÍ POVRCHOVÁ ÚPRAVA
barevný lak dle barevnice Barevný lak

STANDARDNÍ BALENÍ
MO karty: 24 ks (8,8,8)

STANDARD SURFACE FINISH
colour lacquer according to colour card
Colour lacquer

STANDARD PACKING
retail cards: 24 pcs (8,8,8)

L = délka špendlíku / pin length
d = ø drátu / wire diameter

56 SIMPLEX DĚTSKÉ BEZPEČNOSTNÍ • SIMPLEX CHILDREN SAFETY PINS

Art.	Velikost / Size	L / d (mm)	Materiál / Material
56052		3 52/1,10	nerez • plast / stainless steel • plastic

STANDARDNÍ POVRCHOVÁ ÚPRAVA
barva plastu - bílá, žlutá, růžová, modrá

STANDARDNÍ BALENÍ
MO karty: 4 ks
sypané: 100 ks

STANDARD SURFACE FINISH
colours - white, yellow, pink, blue

STANDARD PACKING
retail cards: 4 pcs
loose: 100 pcs

L = délka špendlíku / pin length
d = ø drátu / wire diameter

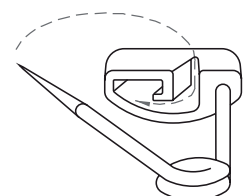



UKÁZKA BALENÍ • ILLUSTRATION OF PACKING • 5

55 DUPLEX - BAREVNÉ • DUPLEX - COLORFUL

DUPLEX Color



56 SIMPLEX DĚTSKÉ BEZPEČNOSTNÍ • SIMPLEX CHILDREN SAFETY PINS







ŠPENDLÍKY SPÍNACÍ • SAFETY PINS •

5





z a p í n á m e c e l ý s v ě t



57 DUPLEX SPECIAL • DUPLEX SPECIAL

Art.	Velikost / Size	L / d (mm)	Materiál / Material	ocel kalená / hard steel
57050		3 50/1,00	STANDARDNÍ POVRCHOVÁ ÚPRAVA níkl	
57040		2 40/0,90	STANDARDNÍ BALENÍ sypané:	1000 ks 12 celků (1 celek = 144 ks)
57038		2 1/4 38/0,90	STANDARD SURFACE FINISH nickel	
57028		1 28/0,80	STANDARD PACKING loose:	1000 pcs 12 gross (1 gross = 144 pcs)

58 DUPLEX GOLDIN • DUPLEX GOLDIN

Art.	Velikost / Size	L / d (mm)	Materiál / Material	mosaz / brass
58040		2 40/1,00	STANDARDNÍ POVRCHOVÁ ÚPRAVA níkl, mosaz	
58028		0 28/0,85	STANDARDNÍ BALENÍ MO svazky: MO karty: sypané:	12 ks 18 ks 1000 ks 12 celků (1 celek = 144 ks)
58022		2/0 22/0,65	sdužené: MO svazky: velikosti 3/0, 2/0, 0 MO karty: velikosti 3/0, 2/0, 0	12 ks 30 ks
58019		3/0 19/0,65	STANDARD SURFACE FINISH nickel, brass	
			STANDARD PACKING retail bunches: retail cards: loose:	12 pcs 18 pcs 1000 ks 12 gross (1 gross = 144 pcs)
			assorted: retail bunches: size 3/0, 2/0, 0 retail cards: size 3/0, 2/0, 0	12 pcs 30 pcs

59 DUPLEX NEREZ • DUPLEX STAINLESS STEEL

Art.	Velikost / Size	L / d (mm)	Materiál / Material	neroz • mosaz / stainless steel • brass
59028		1 28/0,80	STANDARDNÍ POVRCHOVÁ ÚPRAVA leštěné	
			STANDARDNÍ BALENÍ sypané:	1000 ks
			STANDARD SURFACE FINISH polished	
			STANDARD PACKING loose:	1000 pcs

L = délka špendlíku / pin length
d = Ø drátu / wire diameter



UKÁZKA BALENÍ • 5 ILLUSTRATION OF PACKING • 5

55 DUPLEX • DUPLEX



z a p í n á m e c e l ý s v ě t



5G DUPLEX SPECIAL ZAHNUTÝ • DUPLEX SPECIAL CURVED

Art. Velikost / Size L / d (mm) • Materiál / Material ► nerez•mosaz / stainless steel•brass

5G040



2 40/0,8

STANDARDNÍ PVRCHOVÁ ÚPRAVA
leštění

STANDARDNÍ BALENÍ
MO karty: 50 ks
sypané: 100 ks

Použití

Speciálně vyvinuto pro Patchwork & Quilting
Nerezová jehla pro ochranu látek před korozí
Tvarově stálé zahnutí pro opakované použití
Ostrý hrot pro snadné pronikání látkou.

STANDARD SURFACE FINISH
polished

STANDARD PACKING
retail cards: 50 pcs
loose: 100 pcs

APPLICATION

Specially developed for Patchwork & Quilting
Stainless steel needle for corrosion protection
Firm shape of curvature for repeated use.
Sharp spike for easy penetration of the fabric.

L = délka špendlíku (orientační) / pin length (orientation)
d = Ø drátu / wire diameter





811 HOLUBÍ JEHLICE • STAINLESS STEEL PIGEON NEEDLES

Art.	V / D (mm)
8100100	120,00/1,30

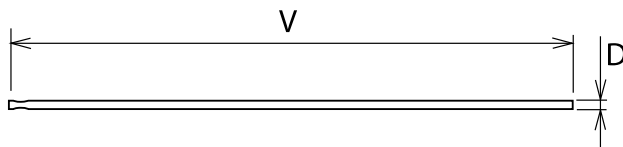

Individuální rozměry na dotaz

Individual dimensions on request

Materiál / Material ► nerez / stainless steel

STANDARDNÍ BALENÍ
sypané: 5 kg

Použití
Ke vsazení do plastových podstavců, slouží k ochraně objektů a historických budov před poškozováním holuby.

STANDARD PACKING
loose: 5 kg

APPLICATION
To inset into plastic pedestal, it is used to protect buildings and historical objects against the damages by pigeons.

813 VĚNCOVÉ SPONY • STEEL WREATH CLASPS

Art.	V / S / D (mm)
8101100	30,00/10,00/1,00

Art.	V / S / D (mm)
8101200	35,00/10,00/1,00

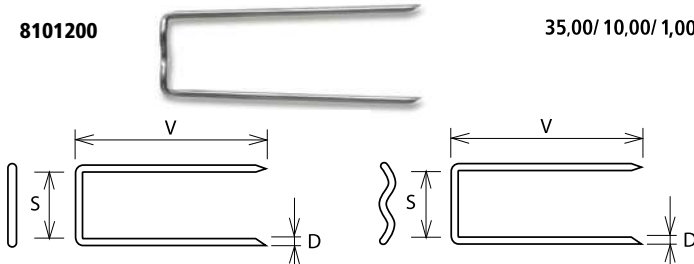

Materiál / Material ► ocel / steel

STANDARDNÍ POVRCHOVÁ ÚPRAVA
bez povrchové úpravy

STANDARDNÍ BALENÍ
MO karty: 50 ks
sypané: 1 kg

Použití
K připevňování dekorací k věncovému korpusu.

STANDARD SURFACE FINISH
raw

STANDARD PACKING
retail cards: 50 pcs
loose: 1 kg

APPLICATION
To fix the decorations to annular corpus.

814 DRŽÁK KNOTU • WICK HOLDER

Art.	V / S / D (mm)
8140100	15,00/3,20/3,00

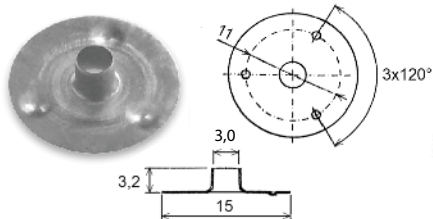

Materiál / Material ► ocel / steel

STANDARDNÍ POVRCHOVÁ ÚPRAVA
nikl, odmaštění

STANDARDNÍ BALENÍ
sypané: 50, 5000 ks

Použití
K připevnění knotu ke dnu svíčky (např. čajové).

STANDARD SURFACE FINISH
nickel, degreased

STANDARD PACKING
loose: 50, 5000 pcs

APPLICATION
To fix the wick to the bottom of the candle (for example tea candles).

814 KONCOVKA LANKA • CABLE END

Art.	V / S / D (mm)
8141100	11,00/5,80/2,20

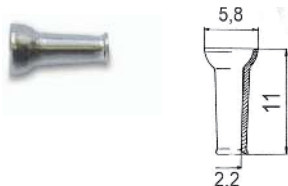

Materiál / Material ► ocel / steel

STANDARDNÍ POVRCHOVÁ ÚPRAVA
nikl

STANDARDNÍ BALENÍ
sypané: 1000 ks

Použití
K zakončování ocelových lanek, šňůrek a provázků.

STANDARD SURFACE FINISH
nickel

STANDARD PACKING
loose: 1000 pcs

APPLICATION
To terminate steel cables, twines and strings.



821 OSIČKY • AXISES

Art.		V / D (mm)
8210100		23,00/1,00
8210800		24,00/1,00
8210300		26,00/1,00
8210200		25,00/1,00
8210400		27,00/1,00
8210600		10,50/2,00

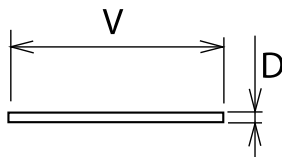

Individuální rozměry na dotaz

Individual dimensions on request

• Materiál / Material ▶ ocel / steel

STANDARDNÍ POVRCHOVÁ ÚPRAVA
nikl, odmaštění

STANDARDNÍ BALENÍ
sypané

Použití

Osičky pro spojování různých dílů, např. osičky ke kolečkům modelů aut.

STANDARD SURFACE FINISH
nickel, degreased

STANDARD PACKING
loose

APPLICATION

Axes for connecting various kinds of components, for example axes for wheels in car models.

823 SEDLOVÉ SPONY • HARD STEEL SADDLE BUCKLES

Art.		• Materiál / Material ▶ kalená ocel / hardened steel
8230100		

8230100

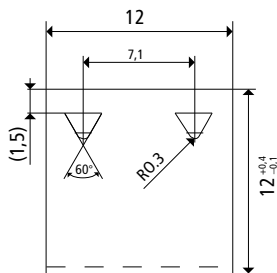
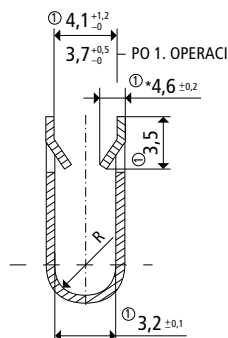
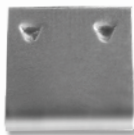

STANDARDNÍ POVRCHOVÁ ÚPRAVA
nikl

STANDARDNÍ BALENÍ
sypané: 3000 ks

Použití

K připevnění potahu na sedlo (motocykly, autosedačky).

STANDARD SURFACE FINISH
nickel

STANDARD PACKING
loose: 3000 pcs

APPLICATION

To fix the coat to the saddle (motorcycles, car seats).



824 KRYT ROHŮ • CORNER COVER

Art.

Velikost / Size

• Materiál / Material ▶ ocel / steel

8240100

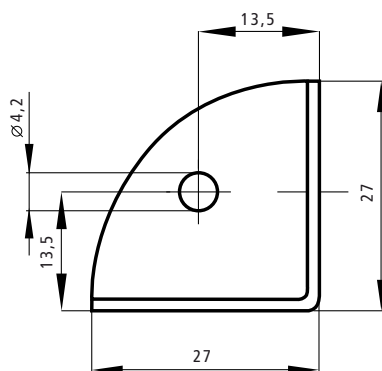

▶
STANDARDNÍ POVRCHOVÁ ÚPRAVA
nikl

STANDARDNÍ BALENÍ
sypané

Použití
Slouží k ochraně rohů pro výrobky z kartonu,
plastu, překližky,...

▶
STANDARD SURFACE FINISH
nickel

STANDARD PACKING
loose

APPLICATION
It is used to protect the corners
for the products of carton, plastic, plywood,...

824 KRYCÍ RŮŽEK • COVERING CORNER

Art.

Velikost / Size

• Materiál / Material ▶ ocel / steel

8240200

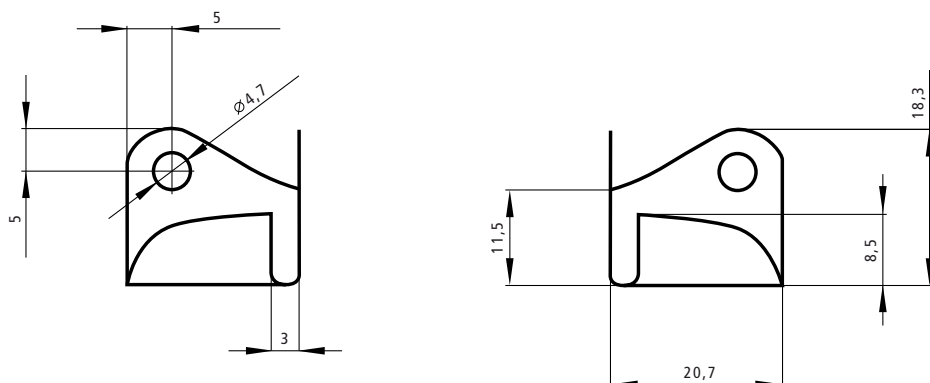

▶
STANDARDNÍ POVRCHOVÁ ÚPRAVA
nikl

STANDARDNÍ BALENÍ
sypané

Použití
Slouží k ochraně růžků pro výrobky z kartonu,
plastu, koženky,...

▶
STANDARD SURFACE FINISH
nickel

STANDARD PACKING
loose

APPLICATION
It is used to protect the corners for
the products of carton, plastic, leatherette,...

POVRCHOVÉ ÚPRAVY • FINISH SURFACES •

zaplníme celý svět



• POVRCHOVÉ ÚPRAVY • FINISH SURFACES

					PROVEDENÍ RYTINY / TYPE OF ENGRAVING	
	HLADKÝ / SMOOTH				NEGATIV	POSITIV
NIKL NICKEL						
ČERNÝ NIKL BLACK NICKEL						
NIKL ANTIK NICKEL ANTIQUE						
MOSAZ BRASS						
STAROMOSAZ OLD BRASS						
MĚĎ COPPER						
STAROMĚĎ OLD COPPER						
NIKL FREE NICKEL FREE						



Provedení povrchových úprav se může lišit (max. 3 stupeň šedé stupnice).
Surface finishing execution can differ (max 3rd degree of the gray scale).

RYTINY KIN • ENGRAVINGS KIN •

z a p í n á m e c e l ý s v ě t



• RAZNICE • STAMPING DIE

STANDARDNÍ DOSTUPNÉ RYTINY • STANDARD AVAILABLE ENGRAVINGS

Arab



A-M 6,
WUK 6

Country



A-M 6, A-M 7,
WUK 6, WUK 7,
FOREVER 7, SPORT

Country



FOREVER 5

Dominant



ROLAND 2
Dominant

Extrém



A-M 6, WUK 6

Forever



FOREVER 7

Hvězdy



WILLY 14, 17

Hvězdy



WUK 6, WUK 7,
A-M 6, A-M 7,
FOREVER 5,
FOREVER 7, SPORT
ROLAND STYLE

Kashmir



A-M 6, WUK 6

Linea



FOREVER 5,
FOREVER 7

Mexiko



A-M 5, WUK 5

New York



A-M 6, WUK 6

Ratolest



A-M 6, WUK 6

Sport



SPORT, CORSO

Tečky



A-M 6, WUK 6

Vavřín



FOREVER 7

Vavřín



FOREVER 5

INDIVIDUÁLNÍ ZÁKAZNICKÉ RYTINY • INDIVIDUAL CUSTOMER ENGRAVINGS •

zapíjíme celý svět



• RAZNICE • STAMPING DIE



Minimální objednávka 5.000 ks
Pořizovací náklady na raznici cca 19 – 25.000 CZK
Nízká cena za ražbu za 1 ks



Min. order qty 5.000 pcs
Initial fixed costs for stamping die app. 750 – 1.000 EUR
Low cost of stamping per 1 pcs

• LASEROVÁNÍ • LASER

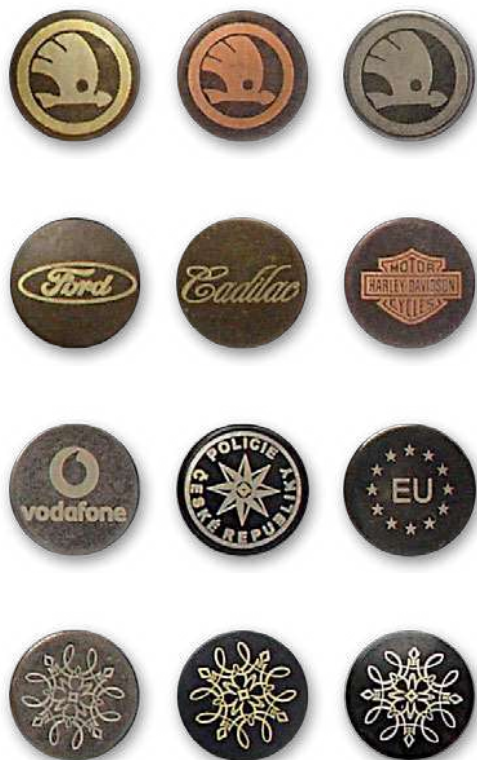

Žádné pořizovací náklady
Nevýhodná cena při velkých objemech zboží
Pevná cena laseru za 1 ks



No initial fixed costs
Not price effective for big quantities
Fixed price of laser per 1 pcs

BAREVNICE • COLOUR CARD •

z a p í n á m e c e l ý s v ě t



• BAREVNÝ LAK

• COLOUR LACQUER



Dostupnost barev dle aktuální skladové zásoby.
Individuální objednávky v minimální výrobní dávce.

Availability according to the current stock.
Individual orders in minimum production lots.

■ ■ Výrobky jsou trvale dostupné jen v označených barvách.
■ ■ Products are permanently available only in marked colors.

■ Špendlík zavírací ocel měkká DUPLEX, 1 (28x0,80mm)
■ Mild Steel Safety Pins DUPLEX, 1 (28x0,80mm)

■ Průchodky s podložkou Ms, 5,5x5x10
■ Brass Eyelets with Washers, 5,5x5x10

BAREVNICE •
COLOUR CARD •

zapíjíme celý svět



- NÝTOVACÍ KNOFLÍKY S HROTY ROLAND DECOR
- PRESS BUTTONS WITH TIP ROLAND DECOR

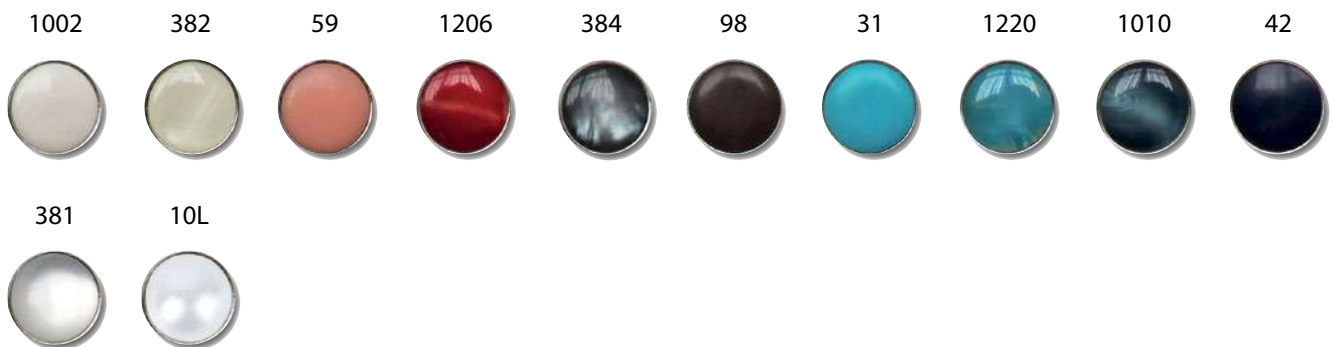

- SNÍMATELNÉ KNOFLÍKY DRESSKING COLOR
- DETACHABLE BUTTONS DRESSKING COLOR





• PNEUMATICKÉ • PNEUMATIC

Art. ▶ 88

8800600



TECHNICKÉ PARAMETRY

Pracovní výška	60 mm
Pracovní hloubka	130 mm
Cykly	30 c/1'
Tlak	5 Bar
Rozměr	120 x 290 x 370 mm
Hmotnost	8 kg

CHARACTERISTICS

Working clearance	60 mm
Depth	130 mm
Theor speed rate	30 c/1'
Suggested working pressure	5 Bar
Overall dimension	120 x 290 x 370 mm
Weight	8 kg

PNEUMATICKÝ LIS OBSAHUJE:

- nastavitelný doraz
- bezpečnostní systém
- nožní spouštěč s plynulým pohybem lisu

PNEUMATIC PRESS CONTAINS:

- adjustable stop
- safety system
- foot starter with smooth motion press

• RUČNÍ • HAND

Art. ▶ 88

8800500



S5

TECHNICKÉ PARAMETRY S5

Pracovní výška	60 mm
Pracovní hloubka	130 mm
Rozměr	90 x 250 x 290 mm
Hmotnost	4,6 kg

CHARACTERISTICS S5

Working clearance	60 mm
Depth	130 mm
Overall dimension	90 x 250 x 290 mm
Weight	4,6 kg

8800400

S3



TECHNICKÉ PARAMETRY S3

Pracovní výška	44 mm
Pracovní hloubka	95 mm
Rozměr	90 x 180 x 320 mm
Hmotnost	3 kg

CHARACTERISTICS S3

Working clearance	44 mm
Depth	95 mm
Overall dimension	90 x 180 x 320 mm
Weight	3 kg

z a p í n á m e c e l ý s v ě t



• Art. ▶ 83

▶ **ART. 12 KNOFLÍKY STISKACÍ NÝTOVACÍ NA SILNÉ LÁTKY**
ART. 12 SNAP FASTENERS FOR THICK MATERIAL

AUTO-MOTO, AMI

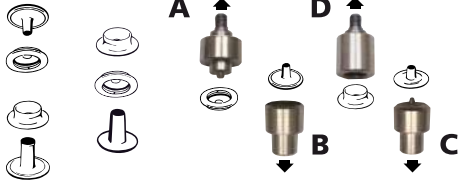

▶ **ART. 13 KNOFLÍKY STISKACÍ NÝTOVACÍ NA STŘEDNĚ SILNÉ LÁTKY**
ART. 13 SNAP FASTENERS FOR MIDDLE THICK MATERIAL

WUK, WUK VODOTĚSNÝ
WUK WATERTIGHT

LORD

PENĚŽENKOVÝ UZÁVĚR
PURSE CLOSURE



▶ **ART. 16 KNOFLÍKY STISKACÍ NÝTOVACÍ S HROTY NA SLABÉ LÁTKY**
ART. 16 SNAP FASTENERS FOR THIN MATERIAL

ROLAND BABY

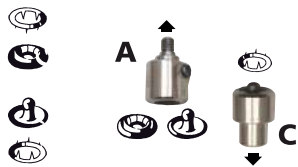

ROLAND STYLE

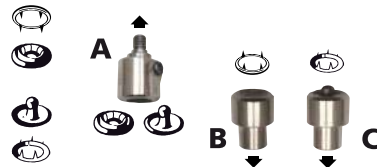

▶ **ART. 23 KNOFLÍKY PRO RUČNÍ POTAHOVÁNÍ**
ART. 23 BUTTONS SELF COVERED

IDEAL

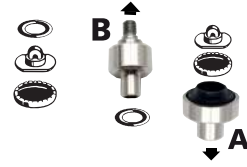

▶ **DĚROVADLO**
PUNCHING TOOL

AUTO-MOTO (Ø3,5 mm)
WUK (Ø3,5 mm)
KROUŽEK
RING



▶ **ART. W5 OBUVNÍ A PLACHTOVÝ KROUŽEK**
ART. W5 SHOE AND SAIL RING

LORD

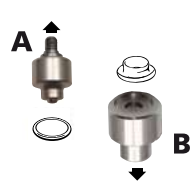

▶ **ART. 3A KALHOTOVÉ HÁKY NÝTOVACÍ**
ART. 3A TROUSERHOOKS, RIVETING

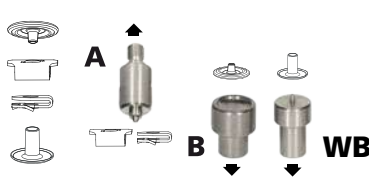

▶ **ART. 15 NÝTOVACÍ NA VELMI SILNÉ LÁTKY**
ART. 15 FOR VERY THICK MATERIAL

KIN DOT

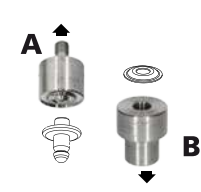

▶ **ART. 26 KNOFLÍKY ZAPÍNAČÍ JEANSOVÉ**
ART. 26 BUTTONS JEANS

FOREVER



▶ **ART. 27 KNOFLÍKY ZAPÍNAČÍ SNÍMATELNÉ**
ART. 27 BUTTONS DETACHABLE

SPORT, DRESSING

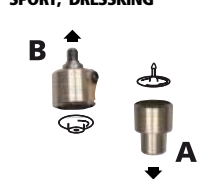

▶ **ART. 28 KALHOTOVÝ NÝT**
ART. 28 TROUSER RIVET

LIBERTY

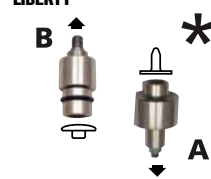

▶ **ART. 31 KALHOTOVÁ SPÍNADLA**
ART. 31 TROUSER HOOKS

Provedení magnetické / Magnetic tools

Provedení s výklopnou lištou / Tools with tipping lath

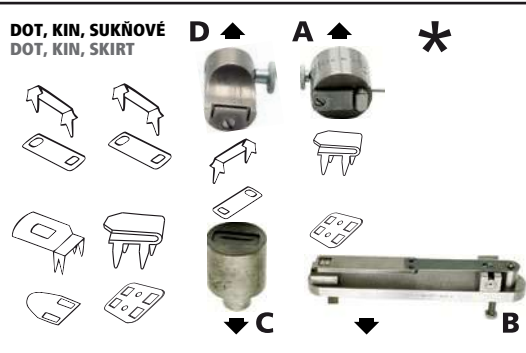
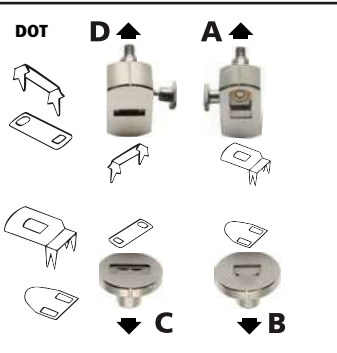

▶ **ART. SEDLÁŘSKÉ NÝTY**
ART. SADDLERY RIVETS



▶ **ART. 40 NÝT S POVLAKEM**
ART. 40 RIVET WITH COATING



Upínací rozměry: horní píst - závit M6
spodní píst - čep Ø12,20 mm

Clamping dimensions: upper tool - thread M6
bottom tool - pivot Ø12,20 mm

* Pouze do ručního lisu S5 nebo lisu pneumatického

To be used only with hand press S5 or pneumatic press

KLEŠTĚ • PLIERS •

z a p í n á m e c e l ý s v ě t



• KLEŠTĚ DĚROVACÍ • PUNCH PLIERS

Art. ▶ 88

8810100



STANDARDNÍ BALENÍ
MO karty: 1 ks

VELIKOSTI DĚROVADEL

- 2 mm
- 2,5 mm
- 3 mm
- 3,5 mm
- 4 mm
- 4,5 mm

POUŽITÍ

K děrování textilu, papíru a dalších materiálů.

STANDARD PACKING
retail cards: 1 pcs

PUNCH SIZES

- 2 mm
- 2,5 mm
- 3 mm
- 3,5 mm
- 4 mm
- 4,5 mm

APPLICATION

Punching of textile, paper and other materials.

• KLEŠTĚ NÝTOVACÍ • SNAP PLIERS

Art. ▶ 88

8820100



STANDARDNÍ BALENÍ
MO karty: 1 ks

POUŽITÍ

K nýtování knoflíků.

Knoflíky stiskací nýtovací na silné látky Auto Moto.
Knoflíky stiskací nýtovací na středně silné látky Wuk.
Knoflíky stiskací nýtovací na slabé látky Roland.

STANDARD PACKING
retail cards: 1 pcs

APPLICATION

For riveting of buttons.

Press fasteners for thick material Auto Moto.
Press fasteners for middle thick material Wuk.
Press fasteners for thin material Roland.

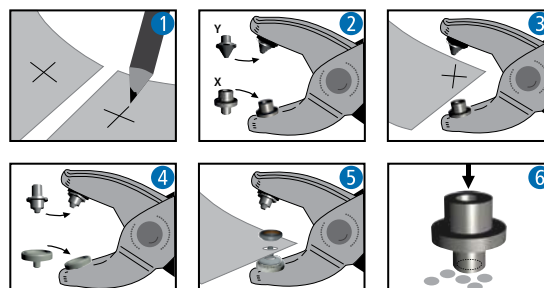

UKÁZKA BALENÍ •
ILLUSTRATION OF PACKING •

z a p í n á m e c e l ý s v ě t



• KLEŠTĚ • PLIERS



NÝTOVACÍ PŘÍSLUŠENSTVÍ • RIVETING ACCESSORIES •

z a p í n á m e c e l ý s v ě t



88 ZAVÍRADLO MO-NÝTOVACÍ SVĚRKA UNI • TOOLS FOR CARDS-CLAMP UNI

Art.

• Materiál / Material ▶ **plast / plastic**

8800100



STANDARDNÍ BALENÍ

MO karty: 1 ks
sypané: 100 ks

Použití

K nýtování knoflíků.

STANDARD PACKING

retail cards: 1 pcs
loose: 100 pcs

APPLICATION

For riveting of buttons.

- Ilustrace použití
- Usage demonstration

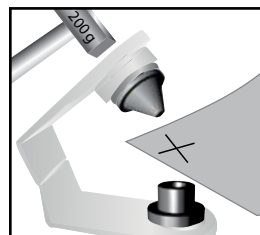

12 NÝTOVACÍ PODLOŽKA PRO AM - WUK • RIVETING WASHER FOR AM - WUK

Art.

D (mm)

• Materiál / Material ▶ **plast / plastic**

13A13



13

12A15



15

Umístění podložky při nýtování / Application of rivet washer

- Vyztužení látky
- Fabric protection

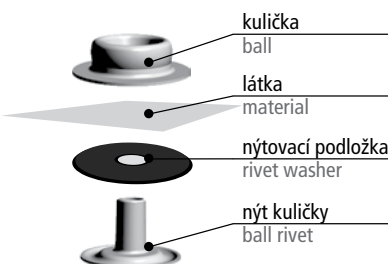

STANDARDNÍ BALENÍ

MO karty: 20 ks
sypané: 500 ks

Použití

Pro snížení výšky nýtu kuličky, zabraňuje poškození materiálu při rozepínání oděvu.

STANDARD PACKING

retail cards: 20 pcs
loose: 500 pcs

APPLICATION

For reduction of ball rivet.
It prevents material from damage at fastening.

KREJČOVSKÉ POTŘEBY • TAILORING NEEDS •

W

zapínáme celý svět



W7 NŮŽKY - ŠTIPKY • THREAD CUTTER

Art.

• Materiál / Material ▶ ocel / steel

W7001



STANDARDNÍ BALENÍ		STANDARD PACKING	
MO karty:	1 ks	retail cards:	1 pcs
Sypané:	12 ks	loose:	12 pcs

W7002



• Materiál / Material ▶ ocel • plast / steel • plastic

STANDARDNÍ POVRCHOVÁ ÚPRAVA		STANDARD SURFACE FINISH	
barva plastu - assort		plastic colour - assort	
STANDARDNÍ BALENÍ		STANDARD PACKING	
MO karty:	1 ks	retail cards:	1 pcs
Sypané:	12 ks	loose:	12 pcs

W9 CENTIMETRY • RULERS

Art.

Velikost / Size (mm)

L (cm)

• Materiál / Material ▶ plast / plastic

W9002



16

150

STANDARDNÍ POVRCHOVÁ ÚPRAVA		STANDARD SURFACE FINISH	
barva plastu - růžová, žlutá, modrá, zelená		plastic colour - pink, yellow, blue, green	
STANDARDNÍ BALENÍ		STANDARD PACKING	
MO karty:	1 ks	retail cards:	1 pcs
Sypané:	12 ks	loose:	12 pcs

STAŽITELNÝ CENTIMETR • RETRACTABLE RULER

W9003



8

150

• Materiál / Material ▶ plast / plastic

STANDARDNÍ POVRCHOVÁ ÚPRAVA		STANDARD SURFACE FINISH	
barva plastu - bílá		plastic colour - white	
STANDARDNÍ BALENÍ		STANDARD PACKING	
MO karty:	1 ks	retail cards:	1 pcs
Sypané:	12 ks	loose:	12 pcs

WC PÁRADLA • SEAM RIPPERS

• Materiál / Material ▶ ocel • plast / steel • plastic

PÁRADLO - KULATÉ MALÉ •
SEAM RIPPER - SMALL ROUND

WC009



STANDARDNÍ POVRCHOVÁ ÚPRAVA		STANDARD SURFACE FINISH	
nikl		nickel	
STANDARDNÍ BALENÍ		STANDARD PACKING	
MO karty:	1 ks	retail cards:	1 pcs
sypané:	50 ks	loose:	50 pcs

PÁRADLO - KULATÉ VELKÉ •
SEAM RIPPER - LARGE ROUND

WC011



STANDARDNÍ POVRCHOVÁ ÚPRAVA		STANDARD SURFACE FINISH	
nikl		nickel	
STANDARDNÍ BALENÍ		STANDARD PACKING	
sypané:	20 ks	loose:	20 pcs



UKÁZKA BALENÍ • ILLUSTRATION OF PACKING • **W**

KREJČOVSKÉ POTŘEBY • TAILORING NEEDS



z a p í n á m e c e l ý s v ě t



WC RUČNÍ JEHLY • HAND SEWING NEEDLES

Art.

• Materiál / Material ▶ ocel / steel

NAVLÉKAČ JEHEL •
NEEDLE THREADER

WC001



STANDARDNÍ POVRCHOVÁ ÚPRAVA
nikl

STANDARDNÍ BALENÍ
MO karty: 3 ks
sypané: 20 ks



STANDARD SURFACE FINISH
nickel

STANDARD PACKING
retail cards: 3 pcs
loose: 20 pcs

ŠÍČÍ, LÁTACÍ A VYŠÍVACÍ JEHLY S NAVLÉKAČEM •
SEWING, TAPESTRY AND DARNING NEEDLES

WC004



STANDARDNÍ POVRCHOVÁ ÚPRAVA
nikl

STANDARDNÍ BALENÍ
MO karty: 30 jehel
+ navlékač jehel



STANDARD SURFACE FINISH
nickel

STANDARD PACKING
retail cards: 30 needles
+ needle threader



UKÁZKA BALENÍ • ILLUSTRATION OF PACKING •

W

WC KREJČOVSKÉ POTŘEBY • TAILORING NEEDS



zapínáme celý svět



WC ŠICÍ SET VELKÝ • BIG SEWING KIT

Art.

• Materiál / Material ▶ plast / plastic

WC010



▶ **STANDARDNÍ PVRCHOVÁ ÚPRAVA**
barva plastu - transparentní

▶ **STANDARD SURFACE FINISH**
plastic colour - transparent

▶ **STANDARDNÍ BALENÍ**

▶ **STANDARD PACKING**

1 ks
obsah: 1x metr krejčovský
1x náprstek
6x nit, různé barvy
50x špendlík se skleněnou hlavou
1x navlékač
1x ruční jehly, sada
1x páradlo kulaté, malé
1x nůžky štipky kovové
12x špendlík spínací, vel. 1, 2, 3
12x knoflík stiskací přišívací, vel. 3
6x knoflík stiskací přišívací, vel. 6
6x háček & očko vel. 6, stříbrný
2x háček & očko vel. 1, stříbrný
5x knoflík černý
5x knoflík transparentní
4x knoflík montérkový

1 pcs
content: 1x ruler
1x thimble
6x thread, mix colors
50x pin straight, glass head
1x needle threader
1x hand sewing needles, set
1x seam ripper, small
1x thread cutter
12x safety pin, size 1, 2, 3
12x snap fastener for sewing, size 3
6x snap fastener for sewing, size 6
6x hook & eye, size 6, silver
2x hook & eye, size 1, silver
5x button black
5x button transparent
4x overall button

WC ŠICÍ SADA CESTOVNÍ • SEWING TRAVEL SET

Art.

• Materiál / Material ▶ plast / plastic

WC006



▶ **STANDARDNÍ PVRCHOVÁ ÚPRAVA**
barva plastu - assort

▶ **STANDARD SURFACE FINISH**
plastic colour - assort

▶ **STANDARDNÍ BALENÍ**

▶ **STANDARD PACKING**

MO karty: 1 ks
obsah: 6x nit, různé barvy
1x navlékač
3x ruční jehly
1x nůžky
1x špendlík spínací
2x knoflík stiskací přišívací
2x knoflík bílý
1x pinzeta
3x špendlík napich. s plast. hlavou

retail cards: 1 pcs
content: 6x thread, mix colors
1x needle threader
3x hand sewing needles
1x scissors
1x safety pin
2x snap fastener for sewing
2x button white
1x tweezers
3x straight pins with plastic head



UKÁZKA BALENÍ • ILLUSTRATION OF PACKING • **W**

WC ŠITÍČKA • SEWINGS



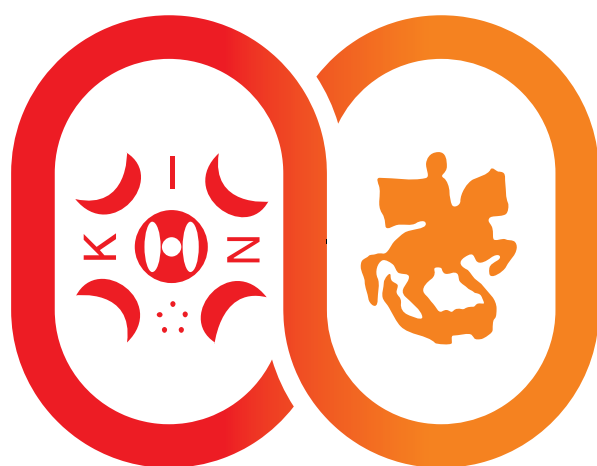

KOH-I-NOOR | *Massag*

#WORK_TOGETHER

KOH-I-NOOR MASSAG, a.s.

**Tradiční výrobce textilní galanterie
Traditional Producer of Textile Haberdashery**

www.kin.eu

www.massag.com